

C576i Self Powered Elliptical Fitness Crosstrainer

Warning: This service manual is for use by Precor trained service providers only. If you are not a Precor Trained Servicer, you must not attempt to service any Precor Product; Call your dealer for service.

This document contains information required to perform the majority of troubleshooting, and replacement procedures required to repair and maintain this product.

This document contains general product information, software diagnostic procedures (when available), preventative maintenance procedures, inspection and adjustment procedures, troubleshooting procedures, replacement procedures and electrical block and wiring diagrams.

To move directly to a procedure, click the appropriate procedure in the bookmark section to the left of this page. You may “drag” the separator bar between this page and the bookmark section to change the size of the page being viewed.

Section One - Things You Should Know

Right, Left, Front, and Back Conventions

In this manual, right, left, front, and back are from the perspective of a user standing on the C576i facing the display enclosure.

General System Information

- The generator performs three functions in the EFX. First, by controlling the amount of electrical load applied to the generator, the user's pedalling resistance is controlled. Second, the generator is used to charge the EFX's internal battery. Lastly, one of the generator's six phase output windings is monitored to determine when the unit is in use and when it is idle. This system also determines the stride rate by determining the operating speed (output frequency) of the monitored generator winding.

Warning and Caution Statements and General Safety Guidelines

Warning statements indicate a particularly dangerous activity. Warning statements you will find in this manual include:

- If the EFX has been in recent use, the load resistors and load resistor mounting bracket may be extremely hot.
- Because this is a self powered unit, it will either be necessary to either equip the unit with the optional external power supply or have an assistant pedal on the unit while voltage measurements are being taken. Because of the danger of working on the unit while it is in motion using the optional external power supply is strongly recommended.
- When the unit is used, stairarms are in motion, the generator will operate and produce potentially hazardous voltages even when the battery is disconnected.
- To remove power from the EFX, the optional external power supply (when equipped) must be disconnected from the wall outlet and the red (positive) lead must be disconnected from the battery. Always ensure that the EFX external power supply is unplugged from the wall outlet and the red (positive) lead is removed from the battery when you inspect or adjust the EFX, or when you isolate, remove, or replace an EFX component.
- Removing the covers exposes high voltage components and potentially dangerous machinery. Exercise extreme caution when you perform maintenance procedures with the cover(s) removed.
- During service operations you will be very close to moving machinery and voltage bearing components. When you perform maintenance procedures with the covers removed, remove jewelry (especially from ears and neck), tie up long hair, remove neck ties, and do not wear loose clothing.

- Exercise caution when touching any wire or electrical component during EFX operation.
- A pinching hazard exists when the unit is operated by turning the crankarms by hand. It is possible to seriously pinch a finger between the crankarm and stairarm. The stairarms should be removed before operating the crankarms by hand. Caution statements are intended to prevent damage to the EFX as a result of the current activity. Caution statements included in this manual are listed below:
- When it is necessary to lift or move the EFX, ensure that the EFX has adequate support and that you use proper lifting techniques.

Safety guidelines you should know and follow include:

- Read the owner's manual and follow all operating instructions.
- Operate the EFX on a solid, level surface. Visually check the EFX before beginning service or maintenance operations. If it is not completely assembled or is damaged in any way, exercise extreme caution while operating and checking the EFX.
- When operating the EFX, do not wear loose clothing. Do not wear shoes with heels or leather soles. Check the soles of your shoes and remove any embedded stones. Tie long hair back.
- Do not rock the unit. Do not stand or climb on the handlebars, display enclosure, or cover.
- Do not set anything on the handlebars, display enclosure, or cover. Never place liquids on any part of the EFX, while performing service.
- To prevent electrical shock, keep all electrical components away from water and other liquids.
- Do not use accessory attachments that are not recommended by the manufacturer-such attachments might cause injuries.

General Information

For the latest exploded view, part number and part pricing information, visit the Precor dealer website at "www.precor.com/connection".

Tools Required

Multimeter	Allen wrench set
Anti-static kit	Screwdriver set
4" - 6" gear puller	7/16" allen key, socket wrench mounted
Precor part number 20030-108 belt gauge	Straight edge
US and metric end wrench set	
US and metric socket wrench set	
Torque wrench, 200 in./lbs.	
Torque wrench, 200 ft./lbs	

Section Two - Preventive Maintenance

Preventive maintenance measures are either scheduled or unscheduled. Scheduled preventive maintenance activities are included here so that you are aware of preventive measures performed on a regular basis.

Regular Preventive Maintenance (Owner)

Cleanliness of the EFX and its operating environment will keep maintenance problems and service calls to a minimum. Precor recommends that you perform the following preventive maintenance schedule.

After Each Use

- Unplug the optional external power supply (when equipped) from the AC outlet.
- Wipe down the covers, handlebars, stairarm wheels and stairarm ramps with a damp cloth.

Daily Maintenance

Clean the EFX's frame, covers, stairarms, stairarm ramps and stairarm wheels using water or a 30:1 solution of Simple Green[®] and water. Wipe the surface of the electronic console with a damp sponge or soft cloth. Dry with a clean towel. A 30:1 solution of Simple Green[®] and water is the only cleaning solution that has been tested and approved for use on the C576i ramps. Use of any other cleaner, may cause degradation of the ramp anodizing and void the ramp warranty. The use of an acid (citric) based cleaner will cause ramp anodizing damage and is not authorized by Precor.

Weekly Maintenance

- Vacuum underneath the EFX, following these steps:
 1. Unplug the optional external power supply (when equipped) from the AC outlet.
 2. Place the EFX on its side.

Note:

Place a drop cloth under the EFX to protect the flooring and to ensure that the EFX handrail is not scratched or damaged.

3. Vacuum the rug or damp mop the floor.
4. Make sure that the floor is dry before returning the EFX to an upright position.

Quarterly Maintenance

1. Remove the rear covers.
2. Check the step up and input belt alignment and tension as in Procedure 5.3.
3. Replace the rear cover.

On-Site Preventive Maintenance (Service Technician)

When you are called to service a EFX, perform these preventive maintenance activities:

- Perform the software diagnostics. Check LED and keypad function. Record the odometer reading.
- Check speed sensor function (is the stride rate displayed when the unit is in operation?). If not, refer to Procedure 6.3
- Visually inspect the drive belts for cracks, fraying or excessive wear.
- When furnished, inspect the optional power supply cords. If a power supply cord(s) is damaged, install a new power supply.
- Visually examine all wires and check connectors and wire connections. Secure connections and replace wiring as necessary.

Procedure 3.1 - Software Access Codes

The C576i uses the standard access codes to provide access to the various software features. In using the standardized access codes the keys are hypothetically numbered left to right with key #1 on the far left and key #7 on the far right. The standard access codes use all sequential key presses. The allowable delay between key presses is short. If too much time is taken between key presses the access procedure will be aborted. If the access is aborted, it will be necessary to start over from the beginning. Refer to Diagram 3.1. The C576i display does not utilize key positions #2 and #3, however, they must be counted to correctly locate keys #4 through #6. On the C576i display key #1 is the **RESET** key and key #4 is the **QUICK START** key.

Standard Access Codes

Diagnostics
Odometer
Club Settings

Keys **RESET**,5,1,7,6,5,7,6,1
Keys **RESET**,6,5
Keys **RESET**,5,6,5,1,5,6,5

Diagram 3.1 - C576i Display Panel



Procedure 3.2 - Accessing the Diagnostic Program

The EFX diagnostic software cycles through the following tests:

- Display Test
- Keyboard Test
- Heart Rate Test
- Battery Test
- RPM Test
- Lift Test
- Brake Test

Procedure

1. Start pedalling and continue to pedal as you perform step 2.
2. Press keys **RESET,5,1,7,6,5,7,6,1.**, sequentially.
3. The message **HARDWARE VALIDATION** will be displayed for a few seconds.
4. The message **DISPLAY TEST** will be displayed followed by every LED on the display being illuminated. Check each LED segment to ensure that all of the segments are illuminated. Press the **ENTER** key to advance to the keyboard test.
5. The message **KEYBOARD TEST** will be displayed followed by a graphical representation of each key position on the display housing. As each key on the display is pressed the key representation is turned "off", indicating that the key is functioning. Check each key in this manner, including the numeric keyboard. Press and hold the **ENTER** key for 2 seconds to advance to the heart rate test.
6. The message **HEART RATE TEST** will be displayed followed by the unfiltered (U), filtered (F) and polar (P) heart rate readings if the heart rate option is installed in the C576i and a chest strap transmitter or a test transmitter is being used. If the heart rate option is not installed in the C576i, the message **NO HEART RATE RECEIVER** will be displayed instead of the heart rate readings. Press the **ENTER** key to advance to the battery test.
7. The message **BATTERY TEST** will be displayed followed by the battery voltage. Press the **ENTER** key to advance to the RPM test.
8. The message **RPM TEST** will be displayed followed by the pulse (power bit) reading and the RPM reading. Press the **ENTER** key to advance to the incline test.
9. The message **LIFT TEST** will be displayed followed by the ramp incline position displayed on the left and the A/D number (incline calibration number) displayed on the right. Press the **ENTER** key to advance to the brake test.

10. The message **BRAKE TEST** will be displayed followed the resistance level and brake level readings. This test allows you to test the brake (resistance) at each resistance level. Press the **ENTER** key to exit the diagnostics program.

Procedure 3.3 - Displaying the Odometer

Procedure

1. Start pedalling and continue to pedal as you perform step 2.
2. With the **PRECOR C576i** banner scrolling, press keys **RESET,6,5**, sequentially.
3. The message **INFORMATION DISPLAY** will be displayed for a few seconds.
4. The message **ODOMETER** will be displayed followed by the total number of strides accumulated. Press the **ENTER** key to advance to total strides.
5. The message **TOTAL STRIDES** will be displayed followed by the total number of strides logged on the C576i. Press the **ENTER** key to advance to hour meter.
6. The message **HOUR METER** will be displayed followed by the total number of hours that the C576i has been in use. Press the **ENTER** key to advance to software version.
7. The message **SOFTWARE VERSION** will be displayed followed by the upper software part number **UPPER APP XXXX-XXX**. Use the ▼ and ▲ keys to display the boot software part number **UPPER BOOT XXXXX-XXX** and lower software part number **LOWER XXXXX-XXX**. Press the **ENTER** key to advance to error log.
8. The message **ERROR LOG** will be displayed followed by the error in log position 1. Each log entry shows the log position, the stride count when the error occurred and the hour meter when the error occurred. For example; **1 ER21 123456 STR 45678 HRS**. The error log can record up to ten error conditions. The error code in position one will be the most recent error and the error in position ten will be the oldest error. If more than ten errors have been logged, only the ten most recent will be displayed. Use the ▼ and ▲ keys to move through the log. Pressing and holding the **QUICK START** key for four seconds will clear the log. Press the **ENTER** key to advance to the serial number display.
9. If a serial number has been entered it will be displayed otherwise **NO SERIAL NUMBER** will be displayed. Press the **ENTER** key to exit the odometer program.

Procedure 3.4 - Club Settings

1. Start pedalling and continue to pedal as you perform step 2.
2. Enter the club settings by pressing keys **RESET,5,6,5,1,5,6,5**, sequentially.
3. The message **SET CLUB PARAMETERS** will be displayed for a few seconds.
4. The message **SELECT LANGUAGE** will be displayed followed by the currently selected language. Use the ▼ and ▲ keys to select the language preference. Press the **ENTER** key to advance to units of measurement.
5. The message **SELECT UNITS** will be displayed followed by the currently selected unit of measurement. Use the ▼ and ▲ keys to select either **U.S. Standard** or **METRIC** measurements. Press the **ENTER** key to advance to maximum workout time.
6. The message **SET MAX WORKOUT TIME** will be displayed followed by the currently selected maximum workout time. Use the ▼ and ▲ keys to select the maximum workout time. The maximum workout time may be set between 1 and 240 minutes or no limit. Press **ENTER** to advance to maximum pause time.
7. The message **SET MAX PAUSE TIME** will be displayed followed by the currently selected maximum pause time. Use the ▼ and ▲ keys to select the maximum pause time. The maximum pause time is the that will elapse after the pause key has been pressed until the unit resets. The maximum pause time may be set between 1 and 120 seconds. Press **ENTER** to advance to set cool down time.
8. The message **SET COOL DOWN TIME** will be displayed followed by the currently selected cool down time. Use the ▼ and ▲ keys to select the cool down time. Cool down time is the period of time following the completion of a program for the user to cool down at a reduced work rate. Press **ENTER** to advance to modify custom programs.
9. The message **MODIFY CUSTOM COURSE 1** will be displayed. The modifications instructions will then be displayed. Press **ENTER** to save custom course modifications and to exit club settings program.

Procedure 3.5 - Documenting Software Problems

When a problem is found with either the upper software or lower PCA's, record the information listed below. Refer to Procedure 3.6 to install new upper software. Please note, installing new upper software is only appropriate if a later software version containing a correction for the problem experienced is available. If an appropriate software version is not available the information below must be forwarded to Precor customer support. This information will be used to correct and create new software, whenever it is appropriate. Lower software is "firmware". The PROM in the lower PCA must be replaced to install new lower software, refer to Diagram 6.4.

When a problem occurs, record the following information:

- Model and serial number
- Software part numbers
- User and program number running when the problem occurred
- A description of:
 - a What happened or failed to happen.
 - b The action taken by the user just before the problem occurred.
 - c Problem-related information (such as how far into the program the problem occurred, the work level being used when the problem occurred, etc.).
- The frequency of occurrence.

Procedure 3.6 - Software Uploading Procedure

This unit utilizes an upper PCA software system that is capable of on site upper PCA software uploading (re-programming). The software upload may be accomplished with the use of a PDA (palm device) or a laptop computer.

If a palm device is to be used it must use OS software version 3.2 or higher. Currently, we have only tested devices manufactured by Palm, but other manufacturer's palm devices may also function correctly.

If a palm device is to be used, the appropriate software must be available in the palm device. A PDA containing the appropriate software may be ordered from Precor or it may be downloaded to the PDA from your desktop or laptop computer via the "hot sync" function. With the PDA inserted in the hot sync cradle, download to "Precor IFP" (in field programmer) directory.

If a laptop computer is to be used, the computer's DB9 serial port will be used for the upload.

Upload Procedure

1. The EFX must be "powered down" before the upload procedure can be initiated. Ensure that the EFX has not be used for a sufficient time to allow the lower PCA to completely discharge. The light emitting diode on the lower PCA will go out when the power supply is discharged.
2. If the CSAFE port is in use, temporarily disconnect the RJ-45 cable from the CSAFE port. If the CSAFE port is not in use, temporarily remove the plastic plug from the CSAFE port.
3. Connect the PDA or computer interface cable to the CSAFE port.
4. Select the software file to be uploaded on the palm device or computer.
5. Start pedaling the EFX or power up using the external power supply. When the EFX "powers up" the upload will commence. You must continue to pedal until the upload is complete, approximately 2 minutes.
6. Stop pedaling or disconnect the external power supply when the upload is complete, and allow the lower PCA to completely discharge. The light emitting diode on the lower PCA will go out when the power supply is discharged.
7. Start pedaling the EFX, after it has been allowed to power down, the EFX will now be operating on the newly uploaded software.
8. Thoroughly, check the EFX's function per Section Four.

Section Four - Checking C576i Operation

This section provides you with a quick method of checking EFX operation. Check the operation of the EFX at the end of most maintenance procedures.

Procedure

1. Start striding on the C546i or plug the optional external power supply (when available) into the EFX and the AC outlet.
2. When the **PRECOR** banner displayed, press **QUICK START**.
3. Select Resistance Level 1 and press **ENTER**.
4. Operate the EFX for 4–5 minutes. As you operate the EFX, concentrate on the operating sounds made by the unit. Be on the alert for unusual rubbing, hitting, grinding, or squeaking noises.
5. If the EFX makes unusual noises or the electronic display does not change appropriately, troubleshoot per Section 6.
6. Press the **RESISTANCE ▲** key until you reach Resistance Level 10. Operate the EFX for another 2–3 minutes.
7. If the EFX resistance does not change or the operation of the EFX feels inconsistent compared with Resistance Level 1, troubleshoot per Section 6.
8. Press the **RESISTANCE ▲** key until you reach Resistance Level 20. Operate the EFX for another 2–3 minutes.
9. If the resistance of the C546i does not change or the EFX operation feels inconsistent with Resistance Levels 1 and 10, troubleshoot per Procedure 6.6.
10. Check the LED's mounted on the upper PCA and the function keys displayed on the electronic console by performing Procedure 3.2.
11. Press the **CROSSRAMP ▲** key while viewing the electronic console. Confirm that the foot pads incline and the ramp display increments to 20 as the **CROSSRAMP ▲** key is pressed.
12. Press the **CROSSRAMP ▼** key while viewing the electronic console. Confirm that the foot pads return to a level position and the ramp display decrements to 1 as the **CROSSRAMP ▼** key is pressed.
13. If the incline system of the C576i does not operate properly, troubleshoot per Procedure 6.6.

Procedure 5.1 - Measuring the Resistance of a Generator

Caution

If an external power supply is connected to the EFX, disconnect the external power supply from the EFX before continuing with this procedure.

Procedure

1. Remove the screw at the right rear of the rear cover. Grasp the right side of the rear cover and rotate it counterclockwise to remove the cover. Refer to Procedure 7.1.
2. Remove the two screws that retain the black plastic shield. Remove the black plastic shield from the EFX.
3. Remove the red battery lead from the lower PCA. See Diagram 5.1.

WARNING

Before continuing with this procedure, review the Warning and Caution statements listed in Section One, Things You Should Know.

4. Set the ohmmeter to a range that will conveniently read up to 50 Ω .
5. Remove the six phase generator connector from the lower PCA, refer to Diagram 5.1, below.
6. With an ohmmeter, read between terminals 1 & 2, terminals 1 & 3, terminals 1 & 5, terminals 1 & 6, and terminals 1 & 7 on the six phase generator connector (J1). Each of the readings should be between 36 Ω and 40 Ω .
7. If any of the readings are significantly high or significantly low, remove the intermediate cable from the generator and perform the same measurements as in step 4 on the generator connector. If the readings are now correct check and or replace the intermediate cable. refer to Diagram 5.1. If the readings are still incorrect, remove the six phase generator.
8. Replace the generator per Procedure 7.18. Reconnect the intermediate cable removed in step 5 to the replacement generator and the lower PCA.
9. Reconnect the red battery lead to terminal M6 of the lower PCA.
10. Set the black plastic shield in its mounting position and fasten it with the screws removed in step 2.
11. Set the right side of the rear cover in its mounting position and rotate it clockwise. Ensure that the cover is fully engaged and fasten it with the screw removed in step 1.

Diagram 5.1 - Lower PCA

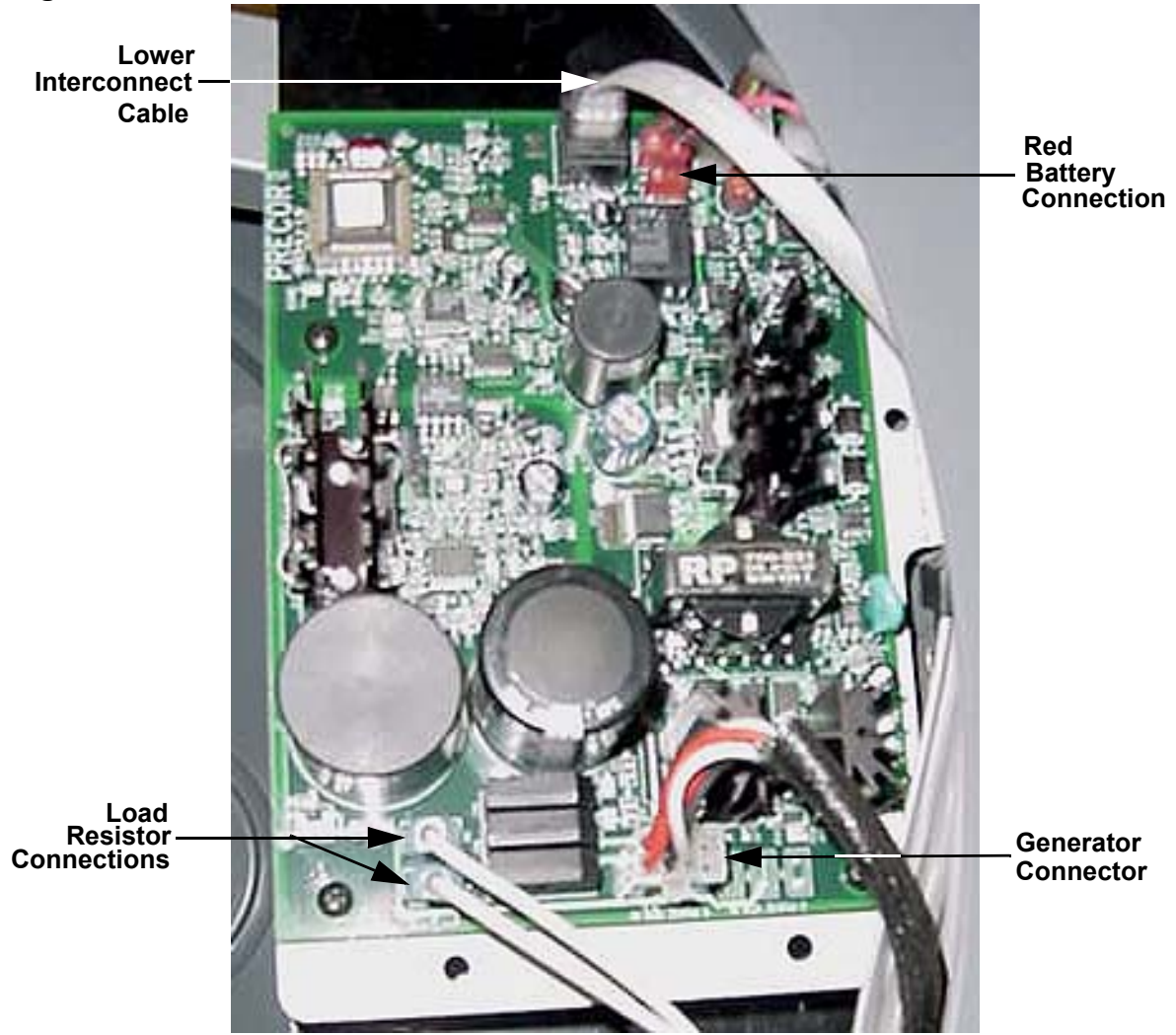

Procedure 5.2 - Inspecting and Adjusting Belt Tension

Procedure

1. Remove both screws at the rear of the rear cover. Grasp the right side of the rear cover and rotate it counterclockwise to remove the cover. Grasp the left side of the rear cover and rotate it clockwise to remove the cover. Refer to procedure 7.1.

WARNING

Before continuing with this procedure, review the Warning and Caution statements listed in Section One, Things You Should Know.

WARNING

If the EFX has been in recent use, the load resistors and mounting bracket may be extremely hot.

2. Remove the two screws that retain the black plastic shield on the left side of the EFX. Remove the black plastic shield from the EFX.
3. Place a 20030-108 or equivalent belt gauge on the input belt as shown in Diagram 5.2.

Diagram 5.2 - Input Belt Tension Measurement

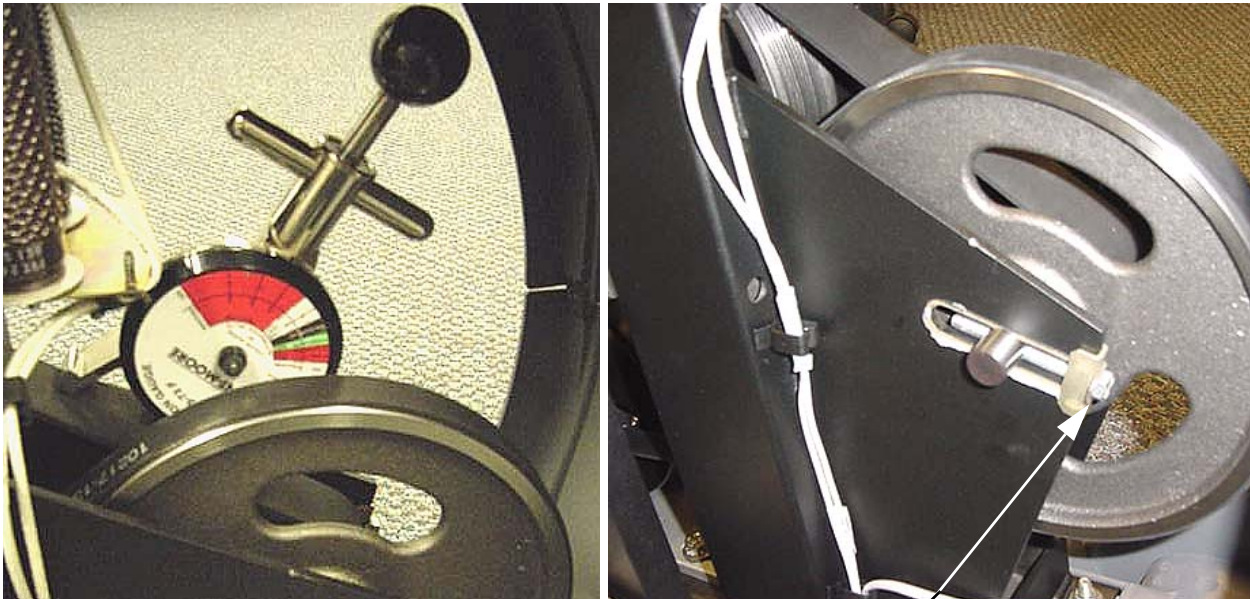

Left Side Adjustment Bolt

4. The belt gauge should read approximately 160 lbs. If the belt tension is significantly high or low the belt tension may be adjusted using the adjustment bolts shown in Diagram 5.2. To adjust the belt tension first straighten the locking tabs on both bolts. When adjusting the tension, turn both bolts equal amounts. When the adjustment is complete the step up pulley shaft must remain perpendicular to the frame and drive belt. Turning the adjustment bolts clockwise will increase belt tension, turning the adjustment bolts counter-clockwise will decrease belt tension.
5. Changing the tension of the input drive belt will also affect the tension of the generator belt. If the input belt tension has been changed, continue with step 7.
6. Place a 20030-108 or equivalent belt gauge on the generator belt as shown in Diagram 5.3.

Diagram 5.3 - Generator Belt Tension Measurement

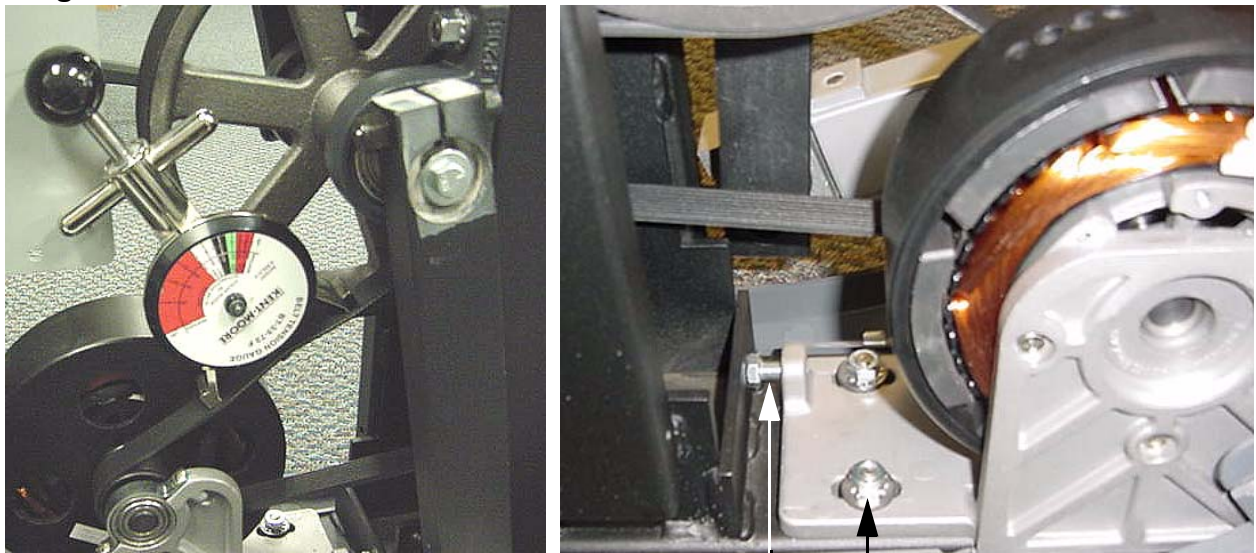

Generator Adjustment Bolt

Generator Mounting Nut

7. The belt gauge should approximately 110 lbs. If the generator belt tension is significantly high or low, it may be adjusted using the adjustment bolt shown in Diagram 5.3. First loosen, but do not remove the four generator mounting nuts. Thread the adjustment bolt into or out of the generator to change the belt tension. When the tension is correct, tighten the locking nut. Tighten and torque the four generator mounting nuts to 200 inch pounds.
8. If either the input pulley belt or the generator belt is being replaced with a new belt, the belt tension should be set 20 lbs. higher than the previous readings. Therefore a new input pulley belt should be tensioned to 180 lbs. and a new generator belt should be tensioned to 130 lbs. Over time and use the belts will “relax” and the tensions will be as stated in steps 4 and 7.
9. Reconnect the red battery lead to terminal M6 of the lower PCA.

10. Set the right side of the rear cover in it's mounting position and rotate it clockwise. Ensure that the cover is fully engaged and fasten it with the screw removed in step 1. Set the left side of the rear cover in it's mounting position and rotate it counterclockwise. Ensure that the cover is fully engaged and fasten it with the screw removed in step 1

Procedure 5.3 - Calibrating the Incline Motor

1. Set the incline at its lowest position and remove the lift cover per Procedure 7.2.
1. Remove the four screws that retain the lower front portion of the front cover. Remove the lower front cover
2. Grasp the center ramp cover and lift it to unsnap it from the ramp. Remove the cover.
3. Remove the two bolts that retain the incline motor yoke assembly in the ramp.
4. Carefully, slide the incline motor yoke out of the ramp and lower the ramp until it is resting on the frame.

Diagram 5.4 - incline Motor Mounting and Calibration

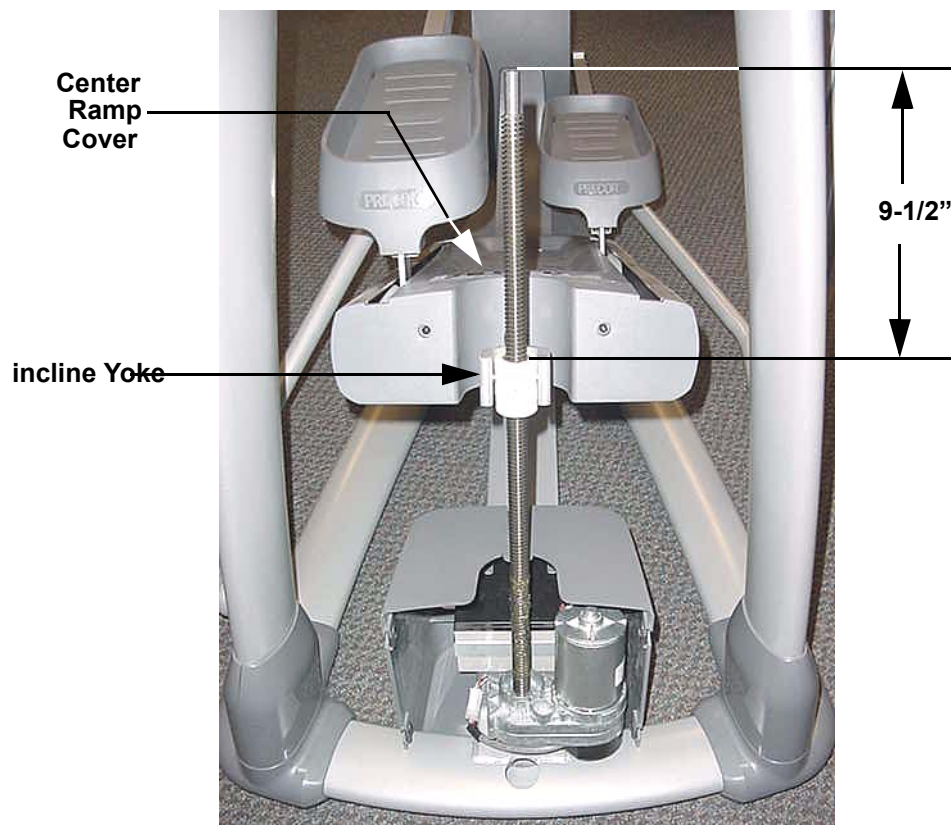

5. Access the incline A/D reading via the Lift Test portion of the Diagnostic Program, see Procedure 3.2.
6. With the A/D number displayed set it for a reading of 127 using the **CROSSRAMP ▼** and **CROSSRAMP ▲** keys.

7. Rotate the incline motor yoke on the incline motor drive screw until the measurement between the top of the incline nut and the end of the incline motor drive screw is 9-1/2 inches. See Diagram 5.4. While rotating the incline motor yoke, do not allow the incline motor drive screw to rotate. If the incline motor drive screw rotates, the A/D number will change. The A/D number must be 127 and the physical measurement must be 9-1/2 inches for the calibration to be correct.
8. Lift the ramp off of the frame and slide the incline motor yoke into the ramp. Do not rotate the incline motor yoke any more than is absolutely necessary to align the incline motor yoke with the ramp.
9. Fasten the incline motor yoke in the ramp with the hardware removed in step 3.
10. Replace the lower front portion of the front cover with the hardware removed in step 1.
11. Replace the lift cover per Procedure 7.2.
12. Operate the incline through its entire range to ensure proper operation.

Procedure 6.1 - Troubleshooting the Lower and Upper Interconnect Cables

Anti-static kits can be ordered from Precor (part number 20024-101).

Troubleshooting the Upper Interconnect Cable

1. Remove the five screws from the rear of the upper display housing. Remove the display housing front panel from the display housing. Disconnect the upper interconnect cable from the upper PCA.
2. Remove the four screws from the access cover below the display. Disconnect the upper interconnect cable from the mid-point connector. Refer to Diagram 6.1

Diagram 6.1 - Data Cable Mid-Point Connector

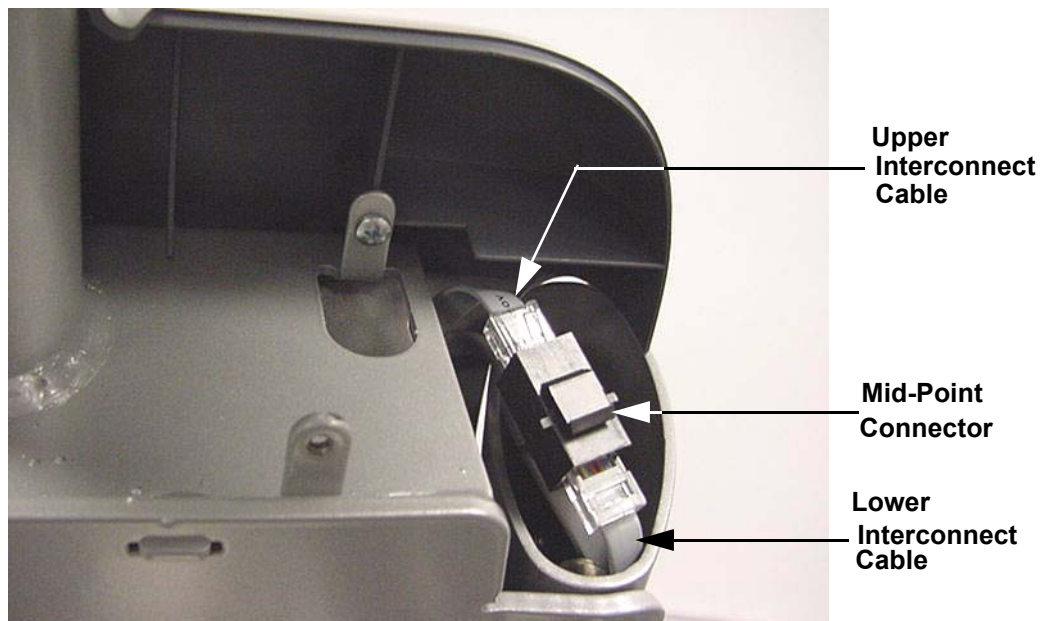

3. External of the upper column, connect a replacement upper interconnect cable to the mid-point connector and the upper PCA.
4. Check operation as described in Section 4. If the unit works properly, replace the upper interconnect cable as described in Procedure 7.4.
5. If the symptoms are unchanged, remove the external upper interconnect cable. Reconnect the internal upper interconnect cable to the mid-point connector and the upper PCA. Set the display housing front panel in its mounting position and fasten it with the five mounting screws removed in step 1. Troubleshoot the lower interconnect cable starting with step 6.

Troubleshooting the Lower Interconnect Cable

6. Remove the right side rear cover as described in procedure 7.1.
7. Disconnect the lower interconnect cable from the mid-point connector and the lower PCA. Refer to Diagram 5.1.
8. External of the frame, connect a replacement lower interconnect cable to the mid-point connector and the lower PCA.
9. Check operation as described in Section 4. If the unit works properly, replace the lower interconnect cable as described in Procedure 7.4.
10. If the symptoms are unchanged, remove the external lower interconnect cable. Reconnect the internal lower interconnect cable to the mid-point connector and the lower PCA. Remove the upper and lower interconnect cables from the mid-point connector. Connect a replacement mid-point connector between the two interconnect cables and retest the unit per Procedure 4.
11. If you have performed all of the procedures above and have been unable to correct the problem, call Precor customer support.

Procedure 6.2 - Troubleshooting the Keypad and Upper PCA

If the function keys on the electronic console are unresponsive, the problem may be either the upper PCA or keypad. The keys on this unit are touch sensitive keys. It is necessary to use the keypad diagnostics to troubleshoot the key functions.

WARNING

Before continuing with this procedure, review the Warning and Caution statements listed in Section One.

1. Attach the anti-static wrist strap to your arm, then connect the ground lead of the wrist strap to the units frame.
2. If the EFX powers up and functions normally until a particular key(s) is pressed, skip to step 12.
3. If a “stuck key” message is immediately displayed when the EFX is powered up, continue with the next step.
4. This condition may be caused by either the keypad or upper PCA.
5. Remove the five screws that fastens the display housing front panel to the display housing backing plate. These screws are located on the rear of the display housing backing plate.
6. Lift the display housing front panel off of the display housing backing plate. Remove the keypad connector from the upper PCA. Refer to Diagram 6.3.

Diagram 6.3 - Upper PCA & Keypad

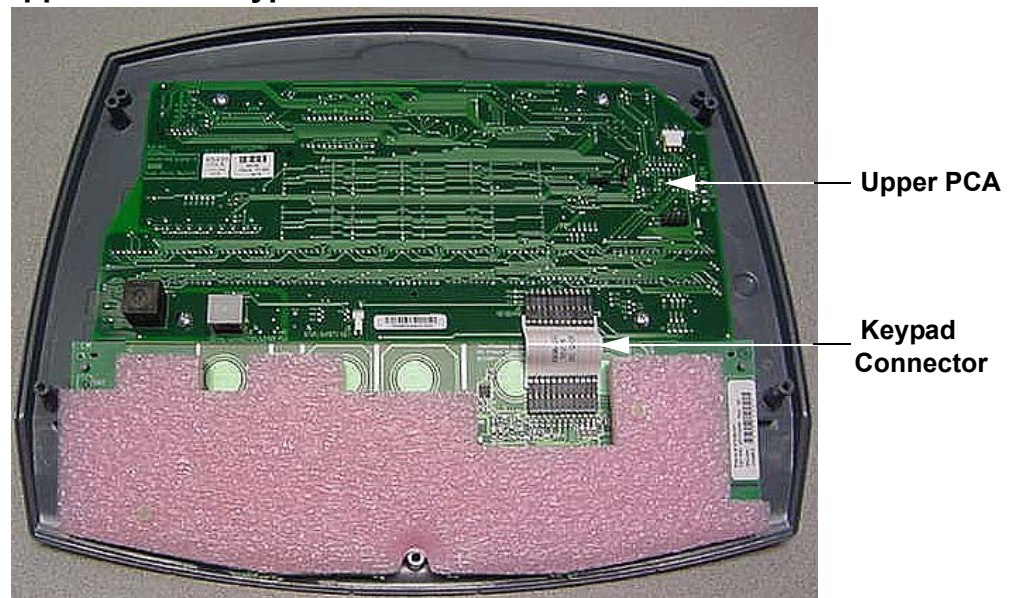

7. If a “stuck key” message is immediately displayed when the EFX is powered up, replace the upper PCA.
8. If a “stuck key” message is not displayed when the EFX is powered up, replace the display housing front panel. The display housing front panel is equipped with the keypad.
9. If you have performed all of the procedures above and have been unable to correct the problem, call Precor customer service.
10. Access the diagnostics program per procedure 3.2. If the key(s) necessary to access the diagnostic program is not functioning, skip to step 14.
11. Test the keypad per Procedure 3.2.
12. If all of the keys test good, the problem may be user error or a key function that is normally disabled during a particular user program.
13. If one or more keys do not function correctly, either the keypad (display housing) or upper PCA could be defective. Replace the display and repeat step 12. If the display housing did not correct the problem, re-install the original display housing and replace the upper PCA.
14. If you have performed all of the procedures above and have been unable to correct the problem, call Precor customer service.

Procedure 6.3 - Upper Display does not Illuminate

1. Because this is self powered unit, the display will not illuminate until it is used or the optional external power supply is equipped. If the optional external power supply is equipped, the display should be constantly illuminated. If the optional external power supply is not equipped, the unit must be used at a stride rate of 20 strides per minute or higher for the display to illuminate.
2. If the optional external power supply is not equipped, skip to step 5.
3. Disconnect the optional external power supply from the EFX and measure between the inner and outer sleeves of the power supply's output jack with a DC voltmeter. You should measure approximately 18 VDC.
4. If the voltage measured in step 3 was significantly low, replace the optional external power supply. If the voltage measured in step 3 was 0 Vdc, disconnect external power supply from its AC outlet and measure the voltage at the AC outlet. If the AC outlet voltage is normal replace the optional external power supply. If the AC outlet voltage is significantly low or 0 Vdc, the AC system must be inspected by an electrician.
5. Troubleshoot the generator per Procedure 6.4.
6. If the generator was found to be good, the problem will be in either the lower PCA, upper PCA or the upper to lower PCA interconnect cables.

Warning

Because this is a self powered unit, it will either be necessary to either equip the unit with the optional external power supply or have an assistant pedal on the unit while voltage measurements are being taken. Because of the danger of working on the unit while it is in motion using the optional external power supply is strongly recommended.

7. Remove the rear cover and disconnect the interconnect cable from the J2 connector of the lower PCA.
8. The following voltage reading must be taken while the unit is in motion. Extreme care must be taken to keep meter leads, hands, etc. clear of all moving parts. Using a DC voltmeter, measure the voltage between TP13 (+5D) and TP4 (DGND). Refer to Diagram 6.4. The voltage measured should be approximately 5 Vdc. If the voltage is significantly low, replace the lower PCA. Additionally, the DS1 LED should illuminate.
9. Reconnect the interconnect cable to the J2 connector of the lower PCA and repeat the voltage measurement in step 8. The voltage measured should be approximately 5 Vdc. If the voltage is significantly low, the problem is in the upper PCA or the upper to lower PCA interconnect cables.

Diagram 6.4 - Partial View of Lower PCA

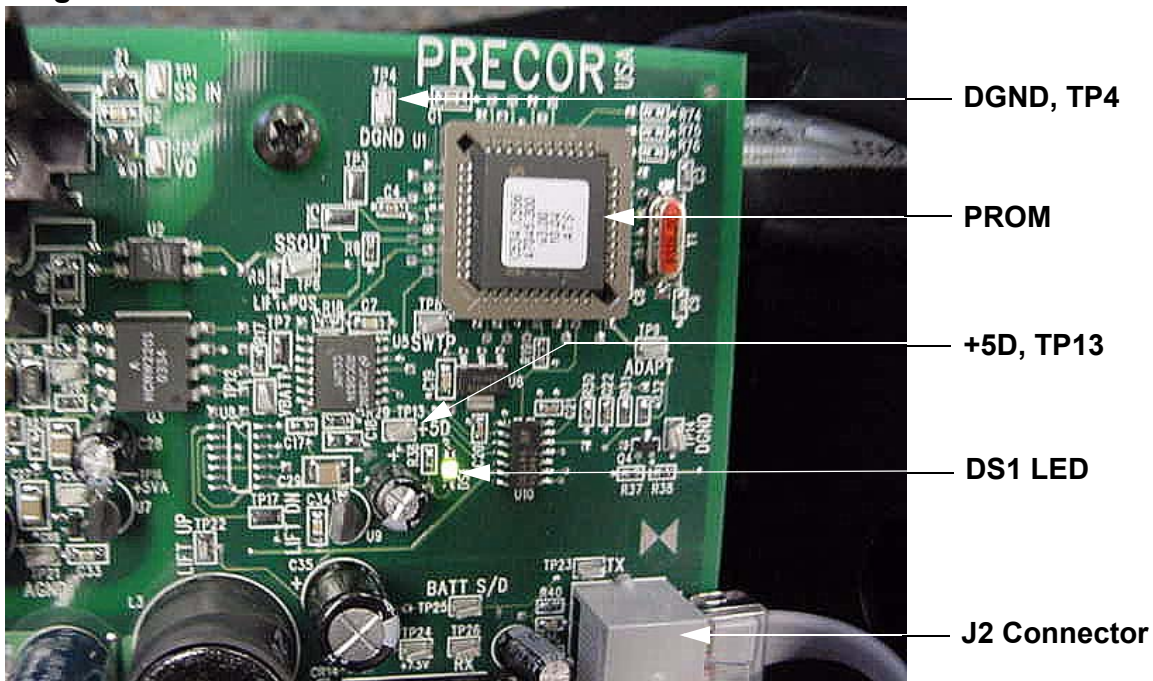

10. Troubleshoot the upper to lower PCA interconnect cables per Procedure 6.1.
11. If the upper to lower interconnect cables are found to be good, replace the upper PCA.
12. If you have performed all of the above tests and are unable to resolve the problem, contact Precor customer support.

Procedure 6.4 - Troubleshooting the Generator

The generator performs three functions in the EFX. First, by controlling the amount of electrical load applied to the generator, the user's pedalling resistance is controlled. Second, the generator is used to charge the EFX's internal battery. Lastly, one of the generator's six phase output windings is monitored to determine when the unit is in use and when it is idle. This system also determines the stride rate by determining the operating speed (output frequency) of the monitored generator winding.

Warning

Because this is a self powered unit, it will either be necessary to either equip the unit with the optional external power supply or have an assistant pedal on the unit while voltage measurements are being taken. Because of the danger of working on the unit while it is in motion using the optional external power supply is strongly recommended.

1. Perform the generator resistance test per Procedure 5.1. If any of the resistance measurements are significantly high or significantly low, replace the generator.
2. The following voltage reading must be taken while the unit is in motion. Extreme care must be taken to keep meter leads, hands, etc. clear of all moving parts. Using an AC voltmeter, measure the voltage between 1 & 3, 2 & 3, 5 & 7 and 6 & 7 on J1 of the lower PCA. All AC voltage readings will vary depending on the unit's stride rate at the time the measurement is taken. At a stride rate of 100 strides per minute, all three voltage readings will be approximately 100 VAC -110 VAC.
3. If any of the six readings in step 2 are significantly low, replace the generator.
4. If you have performed all of the above tests and are unable to resolve the problem, contact Precor customer support.

Procedure 6.5 - Troubleshooting Hand Held Heart Rate

Circuit Description

The hand held heart rate system is actually a dual system, that is, it can accept a heart rate signal from either the hand held heart rate contacts on the unit's handlebar or from a Polar heart rate chest strap transmitter. Refer to Diagram 6.5 and verify that no jumpers are equipped on J13, J14, J15 or J16. Also, verify that there is a jumper equipped on the internal chest strap setting. The internal chest strap setting is the two left hand pins on the three pin connector as shown below in Diagram 6.5. These settings allow the heart rate system to operate on the internal chest strap receiver with the chest strap heart rate priority. That is, if both a chest strap and hand heart rate signal is being received, the system will accept the chest strap signal and ignore the hand held signal. If a chest strap signal is not being received, the system will accept the hand held signal.

Note:

There are four typical failure modes for the hand held/chest strap heart rate system. They are:
 1 - hand held is normal - no chest strap reading; 2 - no hand held reading - chest strap normal;
 3 - no hand held or chest strap reading; 4 - constant or intermittent readings when neither hand held or chest strap are in use.

Diagram 6.5 - Hand held/chest strap heart rate PCA

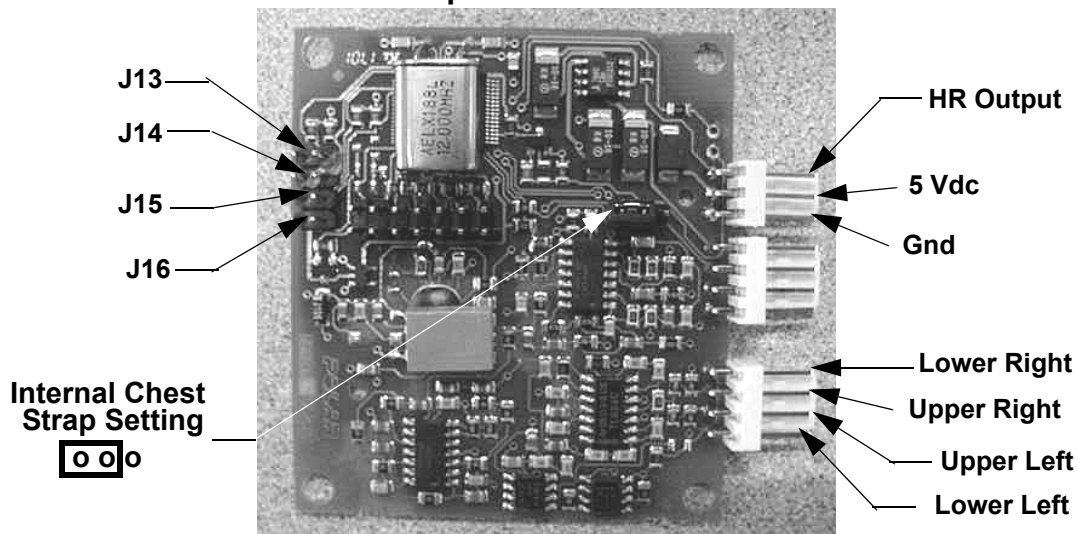

Normal hand held reading - No chest strap reading

1. Access the diagnostic program (Procedure 3.2). Advance to the heart rate display portion of the diagnostic program. Verify that a chest strap signal is not being accepted with either a Polar heart rate test transmitter or a known good chest strap transmitter. If this reading is good, skip to step 3.
2. Using a Polar heart rate test receiver, verify the operation of the chest strap transmitter furnished with the unit. If the Polar heart rate test receiver does not receive a signal, replace the chest strap transmitter.

3. Remove the display housing.
4. Verify the internal chest strap setting is set as shown in Diagram 6.5. Verify that a ferrite bead is installed on the heart rate PCA to upper PCA cable.
5. If the above procedures did not correct the problem, replace the heart rate PCA.

No hand held reading - Normal chest strap reading

6. Access the diagnostic program (Procedure 3.2). Advance to the heart rate display portion of the diagnostic program. Verify that a hand held signal is not being accepted by firmly grasping both the right and left hand held contacts on the handlebars. Cover as much of the contact surface area with your hands as possible (without moving your hands), you should receive a heart rate reading within ten seconds.
7. Temporarily, install a spare jumper on J14 of the heart rate PCA (hand held priority).
8. Repeat the procedure in step 6.
9. If the hand held signal is now being accept, something in the near vicinity is radiating RF (radio frequency) energy that is being received by the chest strap portion of the heart rate PCA. Disabling the chest strap signal proves that it is radiated energy that is causing the problem.
10. If a hand held signal still not being accepted, skip to step 13.
11. The source of the radiated energy must be determined and relocated so that it no longer affects the heart rate PCA. Televisions, cell phones, Cardio-theatre receivers, etc. are possible sources of radiated energy.
12. Remove the temporary jumper from J14 of the heart rate PCA. Re-locate all potential sources of radiation. Pedal the C576i to power it on and repeat the procedure in step 6.
13. Access the diagnostic program (Procedure 3.2). Advance to the heart rate display portion of the diagnostic program. Verify that a hand held signal is not being accepted by firmly grasping both the right and left hand held contacts with the opposite hands, right hand on the left handlebar contacts and left hand on the right handlebar contacts. Cover as much of the contact surface area with your hands as possible, you should receive a heart rate reading within ten seconds. If a hand held signal is still not being accepted, skip to step 15.
14. If a hand held signal was accepted in step 13, the hand held contact wiring is reversed. The end of the wire harness that connects to the hand held contacts in the handlebar is segregated into two groups. One group has blue shrink wrap around it and the other group has black shrink wrap around it. The "blue" group must go to the right hand contacts and the "black" group must go to the left hand contacts. In both groups the black wire must go to the lower contact and the red wire must go to the upper contact. If necessary, rewire the hand held contacts as described above and test as described in step 6.

15. Refer to Diagram 6.5 for the following measurements. With an ohmmeter measure between the “lower right contact” pin on the J1 connector and the lower right hand held heart rate contact on the handlebar. The reading should be 1 Ω or less. Measure between the “upper right contact” pin on the J1 connector and the upper right hand held heart rate contact on the handlebar. The reading should be 1 Ω or less. Measure between the “upper left contact” pin on the J1 connector and the upper left hand held heart rate contact on the handlebar. The reading should be 1 Ω or less. Measure between the “lower left contact” pin on the J1 connector and the lower left hand held heart rate contact on the handlebar. The reading should be 1 Ω or less. If any of the above readings are greater than 1 Ω , replace the heart rate PCA to handlebar wire harness.

No hand held reading - No chest strap reading

16. Access the diagnostic program (Procedure 3.2). Advance to the heart rate display portion of the diagnostic program. Verify that neither a chest strap signal or a hand held signal is being accepted with either a heart rate test transmitter or a chest strap transmitter.
17. Check the plug/connector connections on both the heart rate PCA (J4), and upper PCA (J1).
18. If neither a chest strap signal or a hand held signal is being accepted, measure between the “ground” and “5 Vdc” pins on J4 for 5 Vdc. If 5 Vdc is present, replace the heart rate PCA.
19. If 5 Vdc is not present, remove the connector from J4 of the heart rate PCA. Measure between the “ground” and “5 Vdc” pins of the connector (just removed from the heart rate PCA) for 5 Vdc. If 5 Vdc is present, replace the heart rate PCA. If the 5 Vdc is not present, measure between the corresponding pins of J1 on the upper PCA (red and black wires). If 5 Vdc is not present replace the upper PCA. If 5 Vdc is present, replace the upper PCA to heart rate PCA cable.

Constant or intermittent readings when neither the hand held or chest strap is in use

20. Verify that a ferrite core is clamped around the heart rate PCA to upper PCA cable.
21. Constant or intermittent heart rate readings when neither heart rate system is in use is caused by something in the near vicinity radiating RF energy that is being received by the chest strap portion of the heart rate PCA.
22. Temporarily, install a spare jumper on J14 of the heart rate PCA (hand held priority). Repeat the procedure in step 6.
23. If the hand held signal is now being accept, something in the near vicinity is radiating RF energy that is being received by the chest strap portion of the heart rate PCA. Disabling the chest strap signal proves that it is radiated energy that is causing the problem.
24. The source of the radiated energy must be determined and relocated so that it no longer affects the heart rate PCA. Televisions, cell phones, Cardio-theatre receivers, etc. are possible sources of radiated energy.
25. Remove the spare jumper from J14 of the heart rate PCA. Re-locate all potential sources of radiation. Repeat the procedure in step 6.

Procedure 6.6 - Troubleshooting the Incline System

The incline motor is a 12 Vdc motor with an internally driven 1 K Ω potentiometer used to track ramp position. Because the incline motor is a DC motor, incline motor direction is controlled by the polarity of the DC voltage applied to the incline motor. When a positive voltage is applied to the incline motor, the incline motor will move upward. When a negative voltage is applied to the incline motor, the incline motor will move downward. As the incline motor moves the 1 K Ω potentiometer is rotated via an internal gear drive system. The potentiometer's changing resistance is fed to the incline control system and converted to an A/D (analog to digital) reading that is used in the diagnostics system to indicate ramp position.

The ramp operating system has a battery monitoring system. If the battery voltage falls below 11 Vdc when ramp movement is initiated or the battery voltage falls below 10 Vdc after ramp movement has been initiated, ramp movement will be stopped and the message **"NO RAMP LOW VOLTAGE"** will be displayed. Ramp motion will not be enabled until such time as the battery voltage exceeds the above limits. The battery voltage must be raised to correct this condition either by battery charging or battery replacement. This is strictly a battery problem and not an incline system or incline motor problem.

1. If an Error 40 (no incline movement) is being displayed continue with step 2. If an Error 42 is being displayed (incline out of range) skip to step 12.
2. If the incline moves briefly and then displays an Error 40, skip to step 12. If the incline does not move prior to displaying the Error 40 continue with step 3.
3. Remove the rear cover. Remove the F1 fuse (6.3 amps) from the lower PCA. See Diagram 6.4. Check the fuse resistance using an ohmmeter. The fuse should read 1 Ω or less. If the reading is significantly high, replace the fuse. If the fuse is good or replacing the fuse does not correct the problem, continue with step 4.
4. Enter the diagnostic program per Procedure 3.2. Using the diagnostic program allows you to test the incline system without continuously pedalling the unit. Connect a DC volt meter to the J3 connector on the lower PCA as follows: voltmeter common lead to terminal 3 (black wire) and voltmeter "hot" lead to terminal 2 (red wire). Using the **CROSSRAMP** \blacktriangledown , \blacktriangle keys operate the incline. The voltmeter should read +12 Vdc when the incline is instructed to move upward and -12 Vdc when the incline is instructed to move downward.
5. If when the **CROSSRAMP** keys are pressed, the display does not indicate that the incline should be moving, troubleshoot the upper PCA and keypad per Procedure 6.2.
6. If the voltage measurements in step 4 are correct continue with step 7. If either voltage measurement in step 4 is significantly low, replace the lower PCA.
7. Verify that all of the wires in the intermediate cable (the cable inserted into J3 of the lower PCA) are securely inserted into the connector housing and providing a good electrical connection.

8. Remove the lift cover per Procedure 7.2. Enter the diagnostic program, if necessary, per Procedure 3.2. Using the diagnostic program allows to test the incline system without continuously pedalling the unit. Connect a DC volt meter to the incline motor cable as follows: voltmeter common lead to terminal 2 (brown wire) and voltmeter "hot" lead to terminal 3 (red wire). Using the **CROSSRAMP** ▼,▲ keys operate the incline. The voltmeter should read +12 Vdc when the incline is instructed to move upward and -12 Vdc when the incline is instructed to move downward.
9. If the voltage measurements in step 8 are correct replace the incline motor. If the either voltage measurement in step 4 is significantly low, continue with step 10.
10. Verify that all of the wires in the intermediate cable (the cable inserted in to J3 of the lower PCA) are securely inserted into the connector housing and providing a good electrical connection.
11. If you have performed all of the above tests and are unable to resolve the problem, contact Precor customer support
12. Enter the diagnostic program per Procedure 3.2 and advance to the **Lift Test**. If the A/D reading is either 0 or 255, skip to step 15.
13. Using the **CROSSRAMP** ▼,▲ keys operate the incline. If the A/D reading tracks the incline movement smoothly without skips, calibrate the incline motor per Procedure 5.3 and re-test incline functions in a normal operating mode.
14. If the A/D reading was erratic and did not smoothly follow incline motion, visually check the connections between the intermediate cable and the J3 connector on the lower PCA and between the intermediate cable.
15. Exit the diagnostics program, and leave the unit idle long enough for it to "shut off". Disconnect the red battery lead from terminal M6 of the lower PCA. Remove the intermediate cable from the J3 connector of the lower PCA. Using an ohmmeter, test between terminal 4 (green wire) and terminal 6 (brown wire) of the intermediate cable. The ohmmeter should read approximately 1000Ω.
16. Test between terminal 4 (green wire) and terminal 5 (black wire) of the intermediate cable and between terminal 5 (black wire) and terminal 6 (brown wire) of the intermediate cable. These two readings should total approximately 1000Ω.
17. If the readings in steps 15 and 16 are correct, skip to step 19. If either reading is significantly high or low, continue with step 18.
18. Disconnect the intermediate cable from the incline motor cable. Using an ohmmeter read each of the six wires in the intermediate cable from end to end. Each of the wires in the intermediate cable should read less than 1Ω. If any of the readings are significantly high, replace the intermediate cable. If all of the readings are correct, continue with step 19.
19. Replace the incline motor. Calibrate the incline motor per Procedure 5.3.

Procedure 7.1 - Replacing the Rear Covers

WARNING

Before continuing with this procedure, review the Warning and Caution statements listed in Section One, Things You Should Know.

Replacing the Left and/or Right Side Rear Cover

1. Remove the two screws at the rear of the rear cover.
2. Grasp the left side cover and rotate it clockwise to remove it.
3. Grasp the right side cover rotate it counterclockwise to remove it.
4. Reverse steps 2 and three to replace the left and ride side covers. Replace the screws removed in step 1 to fasten the left and right side covers.

Replacing the Top Section of the Rear Cover

5. Remove the left and right side covers as described above.
6. Loosen, do not remove, the two screws that fasten the top cover to the frame upright.
7. Remove the two screws the fasten the top cover to the front cover and remove the top cover.
8. Set the replacement top cover in its mounting position and fasten it with the four screws removed in steps 2 and 3.
9. Replace the left and right side covers as described above.

Replacing the Rear Section of the Rear Cover

10. Remove the left and right side covers as described above.

Diagram 7.1 - External Power Supply Input Jack

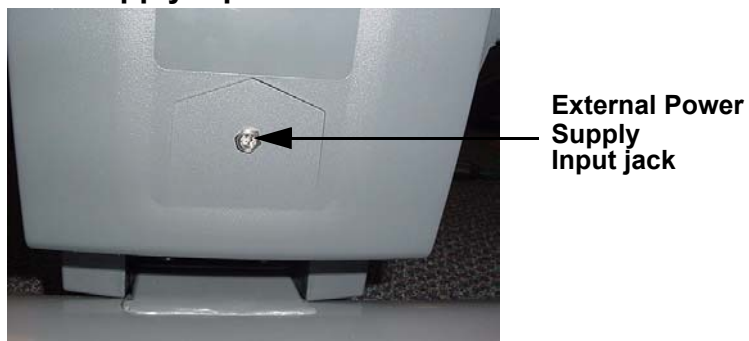

11. Remove the top section of the cover as described above.
12. Remove the nut retaining the external power supply input jack. Refer to Diagram 7.1
13. Remove the external power supply input jack from the cover.
14. Remove the four screws (2 each side) that fasten the cover to the frame. Slide the two wire clips off of the cover's left side. Remove the cover from the EFX.
15. Set the replacement cover in its mounting position and fasten it with the screws removed in step 12. Slide the two wire clips into place on the covers left side.
16. Set the external power supply input jack at its mounting location and fasten it with the nut removed in step 10.
17. Replace the left and right side covers as described above.

Replacing the Front Section of the Rear Cover

18. Remove the left and right side covers as described above.
19. Remove the top section of the cover as described above.
20. Remove the four screws that fasten the rear cover section to the frame. Carefully slide the rear cover section rearwards a couple of inches. to clear the overlap between the front and rear cover sections.
21. Remove the cables from the two lower cable clips on the inside of the front section of the cover.
22. Remove the two screws that fasten the lower PCA mounting bracket to the front section of the cover. Refer to Diagram 7.2.

Diagram 7.2 - Lower PCA Mounting Bracket

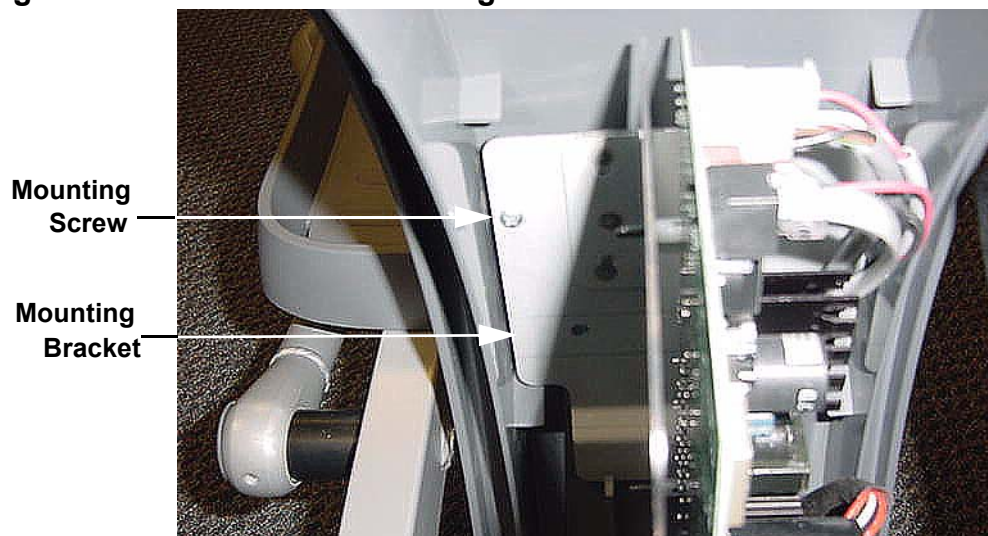

23. Remove the lower PCA and bracket and carefully support it away from the front section of the cover.
24. Remove the small cover at the front portion of the cover section by sliding it forward and off of the front section of the cover. Refer to Diagram 7.3. Remove the two cover mounting screws.

Diagram 7.3 - Small Cover



Small Cover

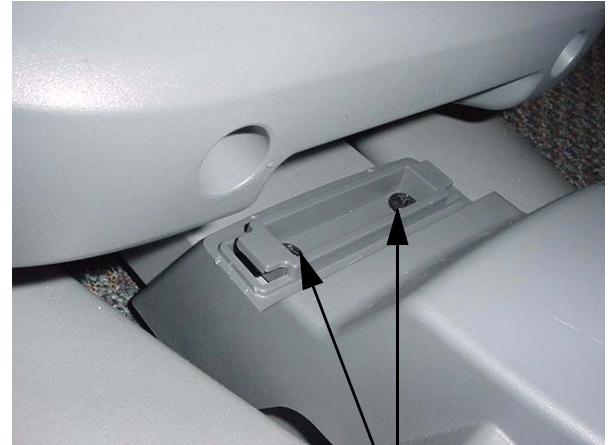

Cover Mounting Screws

25. Remove the front section of the cover from the EFX. Remove the cable clips from the cover and snap them into their mounting positions in the replacement cover.
26. Set the replacement cover in its mounting position. Fasten the cover with the two screws removed in step 25. Slide the small cover, removed in step 24, onto the front section of the cover.
27. Slide the rear section of the cover back into its mounting position and fasten it with the four screws removed in step 20.
28. Set the lower PCA and mounting bracket in its mounting position and fasten it with the two screws removed in step 22.
29. Dress the cables, remove in step 21, into the two lower cable clips on the front section of the cover.
30. Replace the top section of the cover as described above.
31. Replace the left and right cover sides as described above.

Procedure 7.2 - Replacing the Lift Covers

Replacing the Upper Lift Cover Section

1. The large upper section of the front cover is fastened to the lower cover sections. However, there are two plastic clips, one on each side of the upper lift cover, that retain the upper portion of the lift cover to the uprights. To remove the upper lift cover section, lower the incline to its lowest position, to provide clearance.
2. The plastic cover clips must be carefully levered out of their mountings. Insert a narrow flat bladed screw driver in the slot in the front of the cover clip. See Diagram 7.4.

Diagram 7.4 - Lift Cover Clip

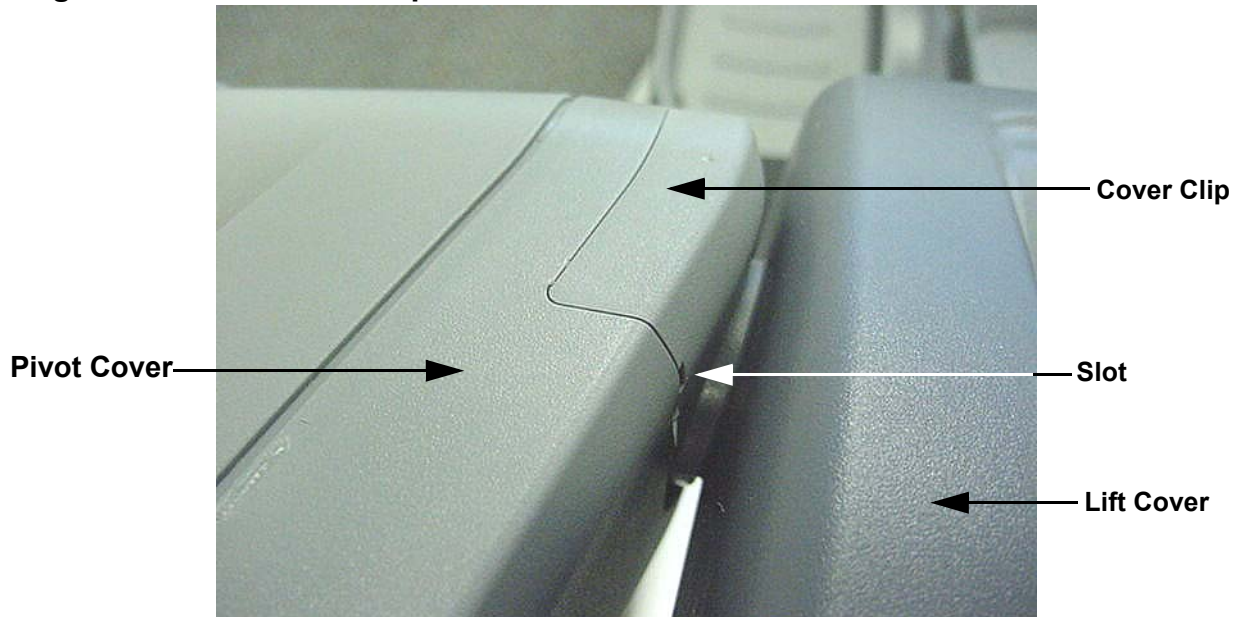

3. Carefully pry the cover clip away from the pivot cover. There are latching tabs in the front and rear of the cover clip. All of the latching tabs must disengage from the pivot cover in order to remove the cover clip.
4. Lift the upper lift cover section off of the lower cover sections.
5. Set the replacement upper lift cover section on in its mounting position on the lower cover sections.
6. Replace the cover clips by setting them in their mounting position and pressing them into place. Press the rear portion of the clip into place first then the front portion of the cover clip.

Replacing the Lower Front Lift Cover Section

7. Remove the upper lift cover section as described above.
8. Remove the four screws that fasten the front cover section to the rear cover section. Remove the front cover section from the EFX.
9. Set the replacement front cover section in its mounting position and fasten it with the four screws removed in step 4.

Replacing the Lower Rear Lift Cover Section

10. Remove the upper and front cover sections as described above.
11. Remove the hitch pin from the clevis at the lower mount of the incline motor. Remove the clevis pin from the lower incline motor mount. Lift the incline motor out of its mounting position and set it on the floor in front of the EFX. Refer to Diagram 754.
12. Remove the two screws that fasten the battery bracket to the rear cover section and remove the battery bracket.
13. Slide the battery out of the rear cover section and set it on the floor beside the incline motor.
14. Remove the two screws that fasten the rear cover section to the frame. Remove the rear cover section from the EFX.
15. Set the replacement rear cover section in its mounting position and fasten it with the screws removed in step 10.
16. Set the battery in its mounting position. Set the battery bracket in its mounting position and fasten it with the screws removed in step 8.

Diagram 7.5 - Rear Cover Section

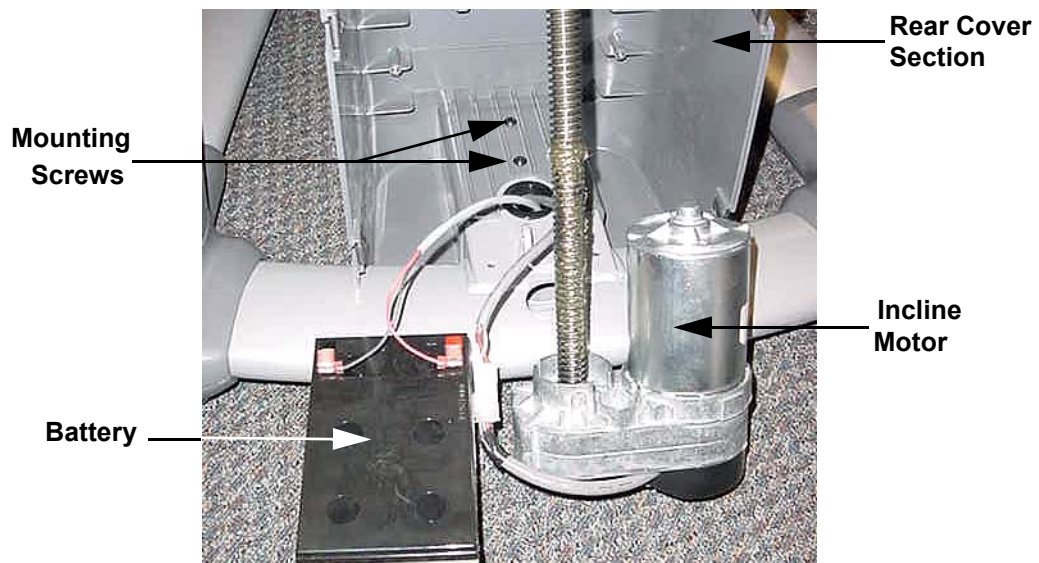

17. Set the incline motor in its mounting position and slide the clevis pin into the incline motor's lower mount. Fasten the clevis pin with the hitch pin.
18. Replace the front and upper cover sections as described above.

Procedure 7.3 - Replacing the Display Enclosure or Upper PCA

Anti-static kits (part number 20024-101) can be ordered from Precor.

The keyboard is part of the display housing front panel. If the keyboard is not functioning properly, replace the display housing front panel.

Removing the Display Housing Front Panel

1. Remove the rear cover and disconnect the red battery lead from terminal M6 of the lower PCA.

WARNING

Before continuing with this procedure, review the Warning and Caution statements listed in Section One, Things You Should Know.

2. Attach the anti-static wrist strap to your arm, then connect the ground lead of the wrist strap to the units frame.
3. Remove the four screws that secure the display housing front panel to the display backing plate.
4. Attach the wrist strap to your arm, then connect the ground lead of the wrist strap to the EFX frame.
5. Disconnect the upper interconnect cable from the upper PCA (connector J5).

Removing and Replacing the Upper PCA

6. Carefully disconnect the keyboard cable from the upper PCA (connector J2).
7. Remove the four screws that secure the upper PCA to the display housing front panel.

Note:

Package the upper PCA in an anti-static bag and document the problem as described in Procedure 3.6, Documenting Software Problems.

Diagram 7.6 - Display Housing Front Panel, Rear View

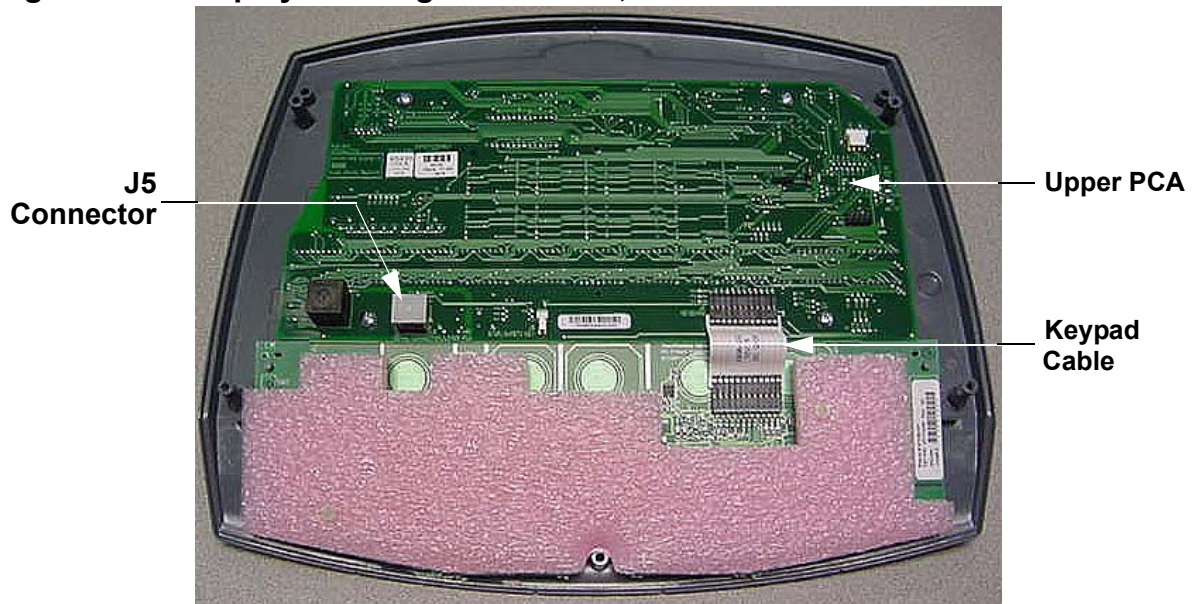

8. Position the upper PCA at its mounting location on the display housing front panel (refer to Diagram 7.6). Replace and tighten the upper PCA mounting screws.
9. Reconnect the keyboard cable to the upper PCA.
10. Reconnect the upper interconnect cable to the upper PCA.
11. Remove the ground lead of the wrist strap from the EFX frame, then remove the wrist strap from your arm.
12. Position the display enclosure on the display plate. Replace and tighten the display mounting screws.
13. Replace the red battery lead removed in step 1 and check unit operation as described in Section Four.

Procedure 7.4 - Replacing the Lower PCA

Removing the Lower PCA

1. Remove the rear cover and disconnect the red battery lead from terminal M6 of the lower PCA.

WARNING

Before continuing with this procedure, review the Warning and Caution statements listed in Section One, Things You Should Know.

2. Remove the right side rear cover per Procedure 7.1.
3. Attach the wrist strap to your arm, then connect the ground lead of the wrist strap to the EFX frame.
4. Disconnect the all of cables and wiring from the lower PCA.
5. Remove the four screws that secure the lower PCA to its mounting bracket, refer to Diagram 7.7.

Diagram 7.7 - Lower PCA

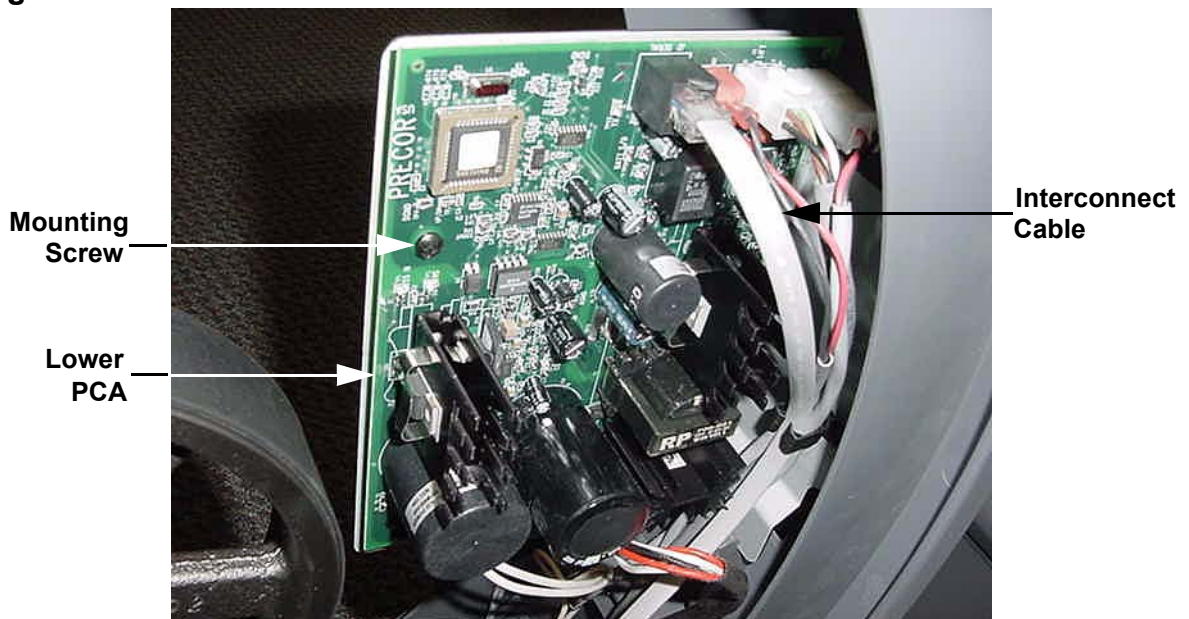

Replacing the Lower PCA

6. Position the replacement lower PCA at its mounting position and fasten the lower PCA with the four screws removed in step 5.

7. Reconnect the lower PCA cables and wiring as follows. Connect the interconnect cable to connector J2. The 2 conductor cable (red and black wires) from the input power jack to the J4 connector. The 6 conductor cable from the generator to connector J1. The 6 conductor cable from the incline motor to connector J5. From the battery, connect the red wire to M6 and the black wire to M7 of the lower PCA. Connect the two leads from the load resistors to M1 and M2, the polarity of the load leads is not critical, either lead may be connected to either the M1 or M2 terminal.
8. Remove the ground lead of the wrist strap from the EFX frame, then remove the wrist strap from your arm.
9. Re-install the rear cover, then check the operation of the C576i as described in Section Four.

Procedure 7.5 - Replacing the Upper or Lower Interconnect Cables

Before you install a new interconnect cable, ensure that the interconnect cable is defective as described in Procedure 6.1.

WARNING

Before continuing with this procedure, review the Warning and Caution statements listed in Section One, Things You Should Know.

1. Attach the wrist strap to your arm, then connect the ground lead of the wrist strap to the EFX frame.

Replacing the Upper Interconnect Cable

2. Remove the display housing per Procedure 7.3.
3. The upper and lower interconnect cables are connected behind the access cover below the the display. Refer to Diagram 6.1.
4. Disconnect the upper interconnect cable from the mid-point connector. Tape the end of the replacement interconnect cable with the to the upper end of the old interconnect cable (display housing end).
5. Carefully pull the old interconnect cable out of the mid-point access hole while feeding the new interconnect cable into the unit. When the new cable is fully into the unit, remove the tape and discard the old interconnect cable. Connect the upper interconnect cable to the mid-point connector and push them into the access hole.
6. Connect the upper interconnect cable to the upper PCA. Replace the display housing per Procedure 7.3.
7. Remove the ground lead of the wrist strap from the EFX frame, then remove the wrist strap from your arm.
8. Check the operation of the EFX as described in Section Four.

Replacing the Lower Interconnect Cable

9. Remove the right side rear cover per Procedure 7.1. Disconnect the interconnect cable from the lower PCA (connector J2). Refer to Diagram 7.7.
10. The upper and lower interconnect cables are connected behind the access cover below the the display. Refer to Diagram 6.1.
11. Disconnect the lower interconnect cable from the mid-point connector. Tape the replacement interconnect cable to the old interconnect cable at the lower PCA end of the old interconnect cable.

12. Carefully pull the old interconnect cable out of the mid-point access hole while feeding the new interconnect cable into the unit. When the new cable is fully into the unit, remove the tape and discard the old interconnect cable. Connect the lower interconnect cable to the mid-point connector and push them into the access hole.
13. Connect the new interconnect cable to the lower PCA.
14. Check the operation of the EFX as described in Section Four.

Procedure 7.6 - Replacing a Crankarm Assembly

Removing a Crankarm Assembly

WARNING

Before continuing with this procedure, review the Warning and Caution statements listed in Section One, Things You Should Know.

1. It is only necessary to remove the right or left side of the rear cover to access the crankarm being replaced. Remove the necessary side(s) of the rear cover.
2. Remove the stairarm assembly as described in Procedure 7.14.

Note:

Notice the position of the two crank arms. When the crankarms are replaced, they must be positioned so that they are 180 degrees opposing.

3. Remove the axle bolt that secures the crankarm to the input pulley shaft. Remove the pinch bolt. Refer to Diagram 7.8. It may be necessary, use a Pitman arm puller or 4" to 6" gear puller to remove the crankarm. Do not use a hammer or mallet to remove the crankarm.
4. If you are removing both crank arm assemblies, repeat steps 2 and 3 for the second crankarm assembly.

Diagram 7.8 - Crankarm

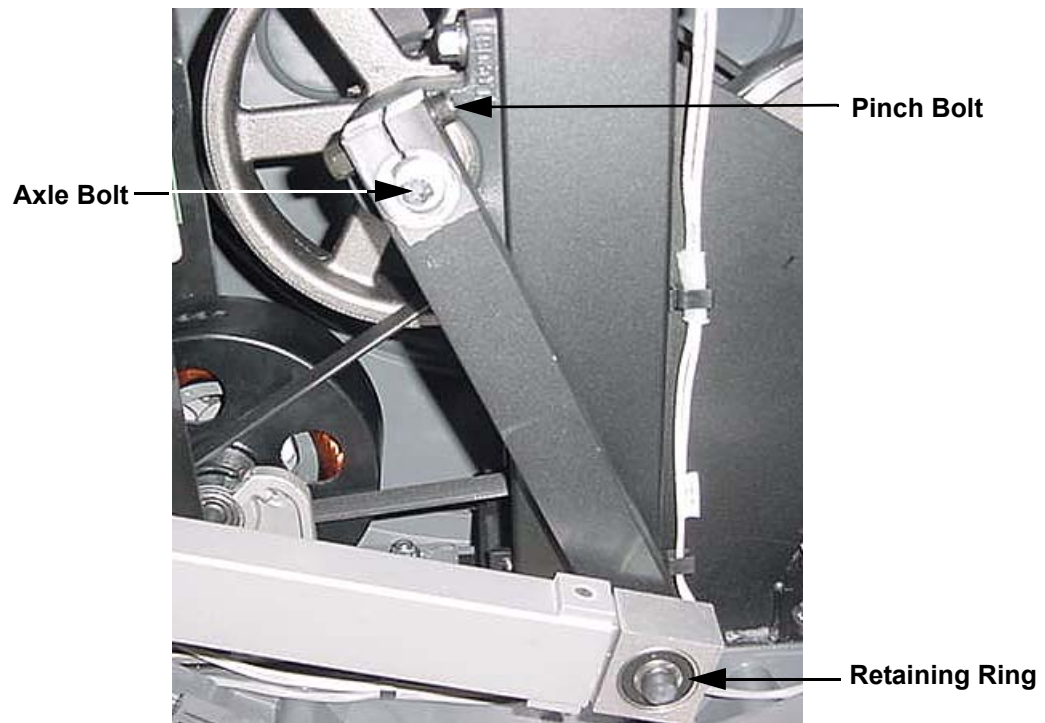

Replacing a Crank Arm Assembly

5. Clean the crankarm mounting bolt threads and the input pulley shaft threads with an alcohol swab. Allow them to dry and apply blue loctite to the crankarm mounting bolt threads.
6. Position the crankarm on the input pulley shaft. Thread and hand tighten the axle bolt into the input pulley shaft. Torque the axle bolt to 200 in/lbs.
7. Replace the pinch bolt and locknut, torque the pinch bolt to 400 inch pounds.
8. Replace the stairarm assembly as described in Procedure 7.12, steps 11 to 12.
9. If you are replacing both crankarm assemblies, repeat steps 6 and 7 for the second crankarm assembly.
10. Replace the right side and/or left side rear cover.

Procedure 7.7 - Replacing a Incline Motor

1. Remove upper and front cover sections per Procedure 7.1.
2. Remove the hitch pin from the clevis at the lower incline motor mount. Remove the clevis pin from the lower incline motor mount.
3. Carefully lift the incline motor out of its mount and set it on the floor in front of the EFX, Refer to Diagram 7.9.

Diagram 7.9 - Incline Motor

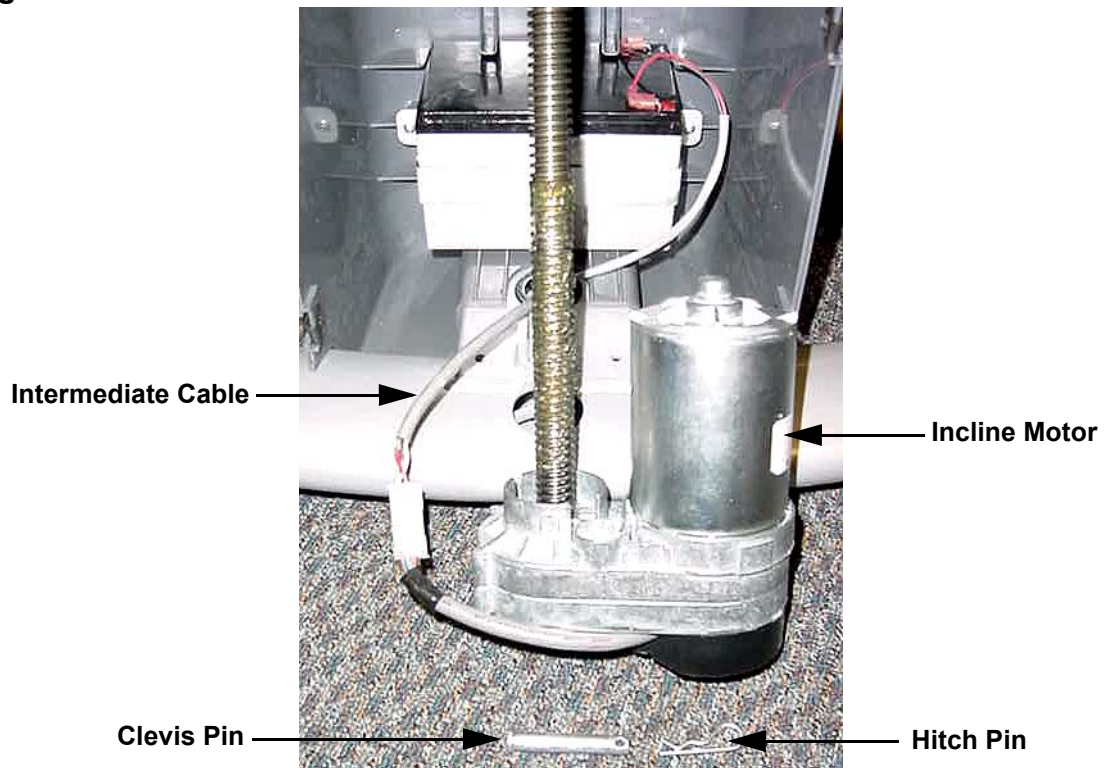

4. Disconnect the intermediate cable from the incline motor cable.
5. Remove the two bolts that fasten the incline motor yoke into the ramp. Refer to Diagram 7.16.
6. Carefully, slide the incline motor yoke out of the ramp and lower the ramp until it is resting on the frame.
7. Thread the incline yoke assembly off of the incline motor's drive screw.
8. Thread the incline yoke assembly, removed in step 7, onto the replacement incline motor's drive screw.

9. Connect the replacement incline motor's cable to the intermediate cable.
10. Mount the incline motor to the EFX frame with the clevis and hitch pins removed in step 2.
11. Calibrate the incline motor per Procedure 5.3.
12. Replace front and upper cover sections per Procedure 7.1.
13. Check the operation of the EFX as described in Section Four.

Procedure 7.8 - Replacing the Input Pulley Belt

WARNING

Before continuing with this procedure, review the Warning and Caution statements listed in Section One, Things You Should Know.

1. Remove the left and right side rear covers per Procedure 7.1.
2. Remove the stairarm assemblies as described in Procedure 7.14
3. Remove the crankarm assemblies as described in Procedure 7.7.
4. Remove the input pulley assembly per Procedure 7.10.
5. Remove the left and right tension bolts, locking tabs and brackets from the step up pulley assembly. Remove the generator belt from the generator's pulley.
6. Slide the step up pulley assembly with both the generator and input pulley belts out of the drive unit.
7. Remove the input pulley belt. Set the replacement input pulley belt in its mounting position on the step up pulley assembly.
8. Set the step up pulley assembly with the generator and input belt at its mounting position in the drive unit. Replace the tensioning bolts, locking tabs and brackets removed in step 6. Thread, but do not tighten, the left and right tension bolts into the step up pulley shaft.
9. Place the other end of the generator belt on the generator's pulley.
10. Place the other end of the input pulley belt on the input pulley assembly and mount the input assembly per Procedure 7.10
11. Replace the crankarm assemblies per Procedure 7.7.
12. Replace the stairarm assemblies per Procedure 7.14
13. Tension both belts per Procedure 5.2. Note the differences between tensioning a new belt and an existing (used) belt.
14. Check the operation of the EFX as described in Section Four.

Procedure 7.9 - Replacing the Generator Pulley Belt

WARNING

Before continuing with this procedure, review the Warning and Caution statements listed in Section One, Things You Should Know.

1. Remove the left and right side rear covers per Procedure 7.1.
2. Remove the stairarm assemblies as described in Procedure 7.14
3. Remove the crankarm assemblies as described in Procedure 7.7.
4. Remove the input pulley assembly per Procedure 7.10
5. Remove the left and right tension bolts, locking tabs and brackets from the step up pulley assembly.
6. Remove the three generator mounting screws shown in Diagram 7.19.
7. Remove the two bearing clamp screws shown in Diagram 7.20. Remove the bearing clamp.
8. Lift the generator and remove its drive belt.
9. Slide the step up pulley assembly with both the generator and input belts out of the drive unit.
10. Remove the generator belt. Set the replacement generator belt in it's mounting position on the step up pulley assembly.
11. Set the step up pulley assembly with the generator and input belt at its mounting position in the drive unit. Replace the tensioning bolts, locking tabs and brackets removed in step 6. Thread, but do not tighten, the left and right tension bolts into the step up pulley shaft.
12. Lift the generator and place the drive belt around the generator's pulley.
13. Replace and tighten the three generator mounting screws removed in step 6. Set the bearing clamp in its mounting position, replace and tighten the two bearing clamp mounting screws removed in step 7.
14. Mount the input assembly per Procedure 7.14.
15. Replace the crankarm assemblies per Procedure 7.7.
16. Replace the stairarm assemblies per Procedure 7.10.
17. Tension both belts per Procedure 5.2. Note the differences between tensioning a new belt and a existing (used) belt.

18. Check the operation of the EFX as described in Section Four.

Procedure 7.10 - Replacing the Input Pulley Assembly

WARNING

Before continuing with this procedure, review the Warning and Caution statements listed in Section One, Things You Should Know.

1. Remove the left and right side rear covers per Procedure 7.1.
2. Remove the stairarm assemblies as described in Procedure 7.14.
3. Remove the crankarm assemblies as described in Procedure 7.7
4. Remove the input pulley assembly mounting nuts (2 per pillow block bearing).
5. Straighten the locking tabs and turn the left and right tension bolts counterclockwise until tension is removed from the both belts. (Refer to Diagram 5.2)

Diagram 7.10 - Input Pulley Assembly

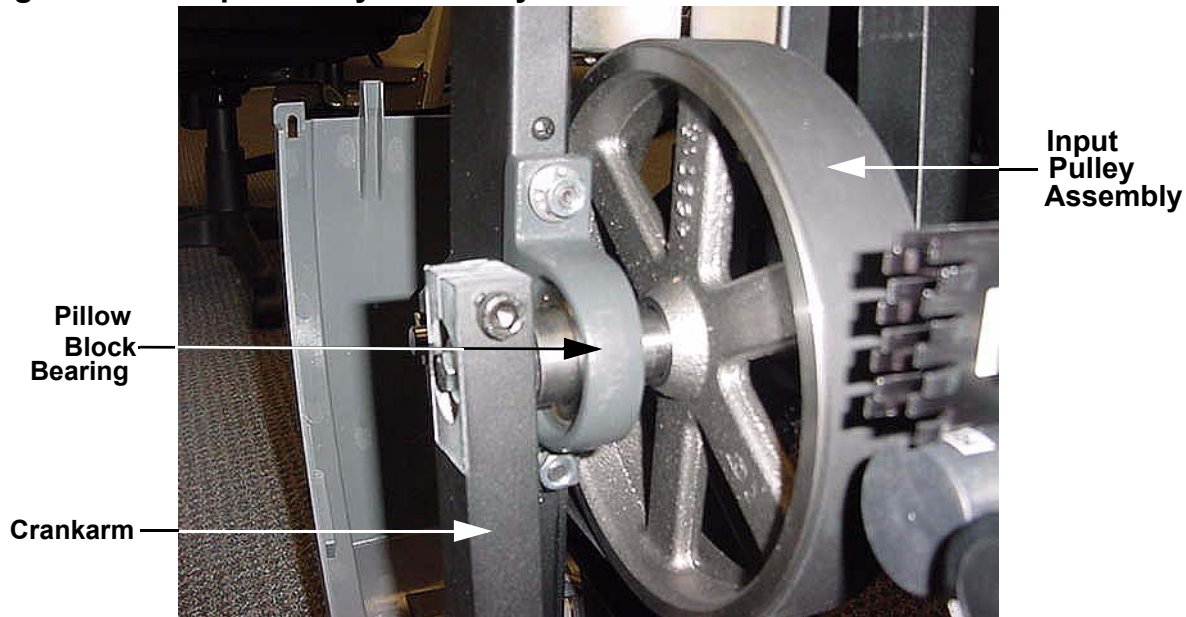

6. Remove the input pulley assembly. Slide input pulley belt off of the input pulley assembly.
7. Hold the replacement input pulley assembly at it's mounting position and slide the input belt over and past the pillow block bearing and onto the input pulley assembly.
8. Replace the nuts on the pillow block bearings and torque them to 400 inch pounds.

9. Replace the crankarms per Procedure 7.7. The crankarms must be parallel to the frame uprights. Refer to Diagram 7.10. If necessary loosen the four drive unit mounting bolts, align the drive unit and torque the drive unit mounting bolts to 400 inch pounds.
10. Tension both belts per Procedure 5.2. Note the differences between tensioning a new belt and a existing (used) belt.
11. Replace the left and right side rear covers.

Procedure 7.11 - Replacing the Step-Up Pulley Assembly

WARNING

Before continuing with this procedure, review the Warning and Caution statements listed in Section One, Things You Should Know.

1. Remove the left and right side rear covers per Procedure 7.1.
2. Remove the stairarm assemblies as described in Procedure 7.14.
3. Remove the crankarm assemblies as described in Procedure 7.7.
4. Remove tension from the input pulley and generator belts as described below:
 - a. Straighten the locking tabs and turn the left and right tension bolts counterclockwise until tension is removed from the both belts. (Refer to Diagram 5.2)
 - b. Remove both tension bolts and slide the input belt off of the step up pulley assembly.
5. Place the input belt and step up belt in place on the replacement step up pulley. Set other end of the generator belt on the generator pulley.
6. Replace the tension bolts and associated hardware removed in step 4b.
7. Tension both belts per Procedure 5.2. Note the differences between tensioning a new belt and a existing (used) belt.
8. Replace the crankarms per Procedure 7.7.
9. Replace the left and right side rear covers.

Procedure 7.12 - Replacing a Stairarm Wheel

Procedure

WARNING

Before continuing with this procedure, review the Warning and Caution statements listed in Section One, Things You Should Know.

1. Remove the lift cover per Procedure 7.2.
2. Grasp the center ramp cover and lift it upwards to unsnap it from the ramp. Remove the center ramp cover from the EFX and set it aside.
3. Remove the two screws that fasten the ramp end cap to the ramp. Remove the ramp end cap. Refer to Diagram 7.11.

Diagram 7.11 -Ramp Assembly



4. The left side and/or right side ramp trim will need to be removed in order to access the stairarm wheels.
5. Loosen, but do not remove, the five screws that fasten ramp trim(s) required to access the wheel(s) being replaced. Slide the ramp trim(s) off the front of the ramp.
6. Remove the screw retaining the wheel being replaced. Refer to Diagram 7.12. Slide the wheel off the stairarm axle.

Diagram 7.12 - Stairarm Wheel



7. Slide the replacement wheel onto the stairarm axle. Fasten the wheel with the hardware removed in step 6. Apply blue loctite to the wheel mounting screws and torque them to 180 inch pounds.
8. Repeat the procedure in steps 6 and 7 for each wheel being replaced.
9. Align the T-nuts on the ramp trim(s) with the channel in the bottom front of the ramp. Slide the trim onto the ramp while feeding each T-nut into the ramp channel. Do not tighten the trim fastening screws at this time. Repeat this procedure with the remaining trim strip, if required.
10. Set the ramp end cap at its mounting position and fasten it with the screws removed in step 3.
11. Align the ramp trim(s) with the ramp end cap and tighten the five trim mounting screws.
12. Set the ramp center cover at its mounting position and press downward to snap it onto place.
13. Replace the lift cover per Procedure 7.2.

Procedure 7.13 - Replacing a Stairarm Pedal

1. Loosen and remove the four screws that fasten the stairarm pedal onto the stairarm. Refer to Diagram 7.13.
2. Remove the stairarm pedal from the stairarm.
3. Set the replacement stairarm pedal at it's mounting position on the stairarm.
4. Install and tighten the stairarm pedal mounting hardware removed in step 2.

Diagram 7.13 - Stairarm Pedal



Procedure 7.14 - Replacing a Stairarm

1. Remove the left and right side rear cover.
2. Remove the cover from the rear of the stairarm. The cover's retaining screw is on the inside and must be accessed from the opposite side of the EFX. Carefully, rotate the stairarm to a position just forward of vertical to gain access to the cover's retaining screw.
3. Remove the lift cover per Procedure 7.2.
4. Grasp the center ramp cover and lift it upwards to unsnap it from the ramp. Remove the center ramp cover from the EFX and set it aside.
5. Remove the two screws that fasten the ramp end cap to the ramp. Remove the ramp end cap. Refer to Diagram 7.11.
6. The left side and/or right side ramp trim will need to be removed in order to access the stairarm wheels.
7. Loosen, but do not remove, the five screws that fasten ramp trim(s) required to access the wheel(s) being replaced. Slide the ramp trim(s) off the front of the ramp.
8. Remove the plastic cap from the stairarm connector. Remove the bolt that fastens the stairarm connector to the stairarm. Retain the bolt, two washers, a steel spacer and a large black spacer for later use. Refer to Diagram 7.14.

Diagram 7.14 - Stairarm and Stairarm Connector

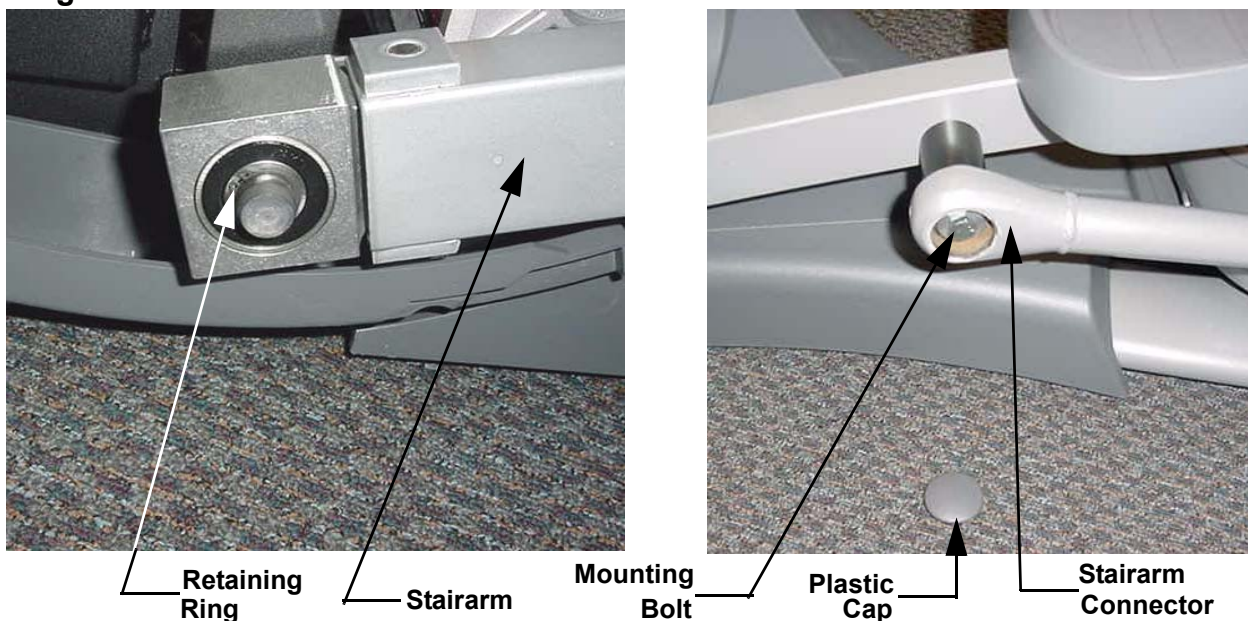

9. Remove the retaining ring that fastens the stairarm to the crankarm and remove the stairarm from the EFX.
10. Remove the stairarm pedal per Procedure 7.13 and install it on the replacement stairarm. Refer to Procedure 7.13.
11. Remove both wheels and slide them onto the replacement stairarm's axle. Apply blue loctite to the wheel mounting screws and torque the wheel mounting screws to 180 inch pounds.
12. Slide the stairarm onto the crankarm and set the stairarm in its ramp track. Fasten the stairarm to the crankarm with the retaining ring removed in step 7.
13. Slide the large black spacer onto its mounting position on the replacement stairarm. Slide the steel spacer into the end of the stairarm connector. Fasten the stairarm connector to the stairarm with the bolt, removed in step 6, and a washer on each side of the steel spacer in the end of the stairarm connector.
14. Align the T-nuts on the ramp trim(s) with the channel in the bottom front of the ramp. Slide the trim onto the ramp while feeding each T-nut into the ramp channel. Do not tighten the trim fastening screws at this time. Repeat this procedure with the remaining trim strip, if required.
15. Set the ramp end cap at its mounting position and fasten it with the screws removed in step 3.
16. Align the ramp trim(s) with the ramp end cap and tighten the five trim mounting screws.
17. Set the ramp center cover at its mounting position and press downward to snap it onto place.
18. Replace the lift cover per Procedure 7.2.
19. Replace the stairarm cover(s) with the hardware removed in step 2.
20. Replace the left and right side covers per Procedure 1.

Procedure 7.15 - Replacing a Ramp Assembly

Procedure

1. Raise the incline to its highest position.
2. Remove both stairarms per Procedure 7.14.
3. Remove the four bolts that fasten the ramp pivot to the ramp. Refer to Diagram 7.15.

Diagram 7.15 - Rear Ramp Mounting

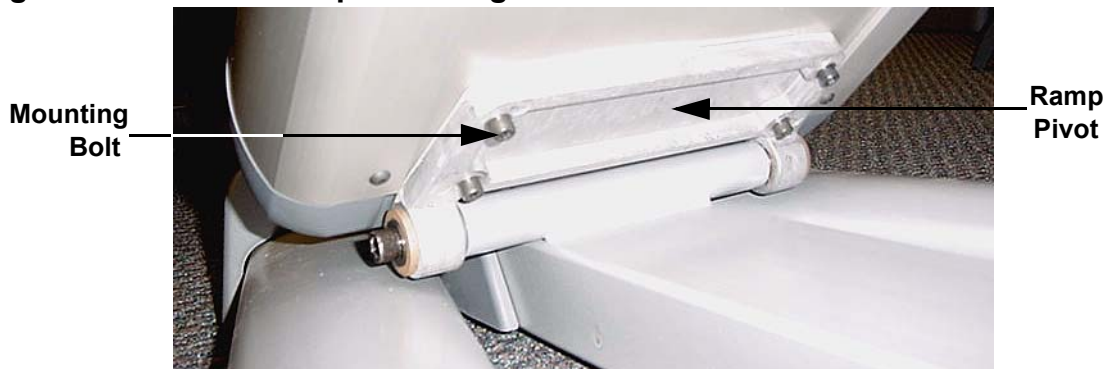

4. Remove the two bolts that fasten the incline yoke into the ramp. Refer to Diagram 7.16. Carefully, slide the incline out of the ramp and lower the ramp to the frame. Take care to not allow the incline yoke to rotate on the incline motor's drive screw. If the yoke can not be returned to the same position it was in before the incline yoke was removed, an incline calibration (Procedure 5.3) must be performed before the incline motor is reinstalled in the ramp.

Diagram 7.16 - Front Ramp Mounting

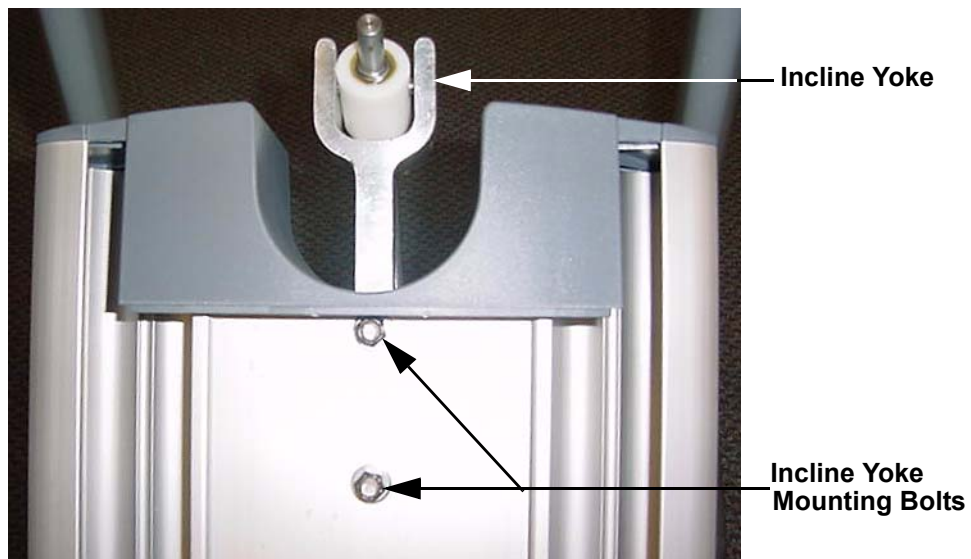

5. Remove the ramp from the EFX.
6. Remove the two screws that fasten the rear ramp end cap to the ramp. Set the rear ramp end cap at its mounting position on the replacement ramp and fasten with the screws removed above.
7. Set the replacement ramp in its mounting position and hand start ramp pivot mounting bolts removed in step 3. Do not tighten them at this time.
8. Slide incline yoke into its mounting position in the ramp and fasten it with the hardware removed in step 4.
9. Apply blue loctite to the four ramp pivot bolts (hand started in step 7) and torque them to 480 inch pounds (40 foot pounds).
10. Slide the stairarm onto the crankarm and set the stairarm in its ramp track. Fasten the stairarm to the crankarm with the retaining ring removed in step 7.
11. Slide the large black spacer onto its mounting position on the stairarm. Slide the steel spacer into the end of the stairarm connector. Fasten the stairarm connector to the stairarm with the bolt, removed in step above, and a washer on each side of the steel spacer in the end of the stairarm connector.
12. Align the T-nuts on the ramp trim(s) with the channel in the bottom front of the ramp. Slide the trim onto the ramp while feeding each T-nut into the ramp channel. Do not tighten the trim fastening screws at this time. Repeat this procedure with the remaining trim strip, if required.
13. Set the ramp end cap at its mounting position and fasten it with the screws removed in step 3.
14. Align the ramp trim(s) with the ramp end cap and tighten the five trim mounting screws.
15. Set the ramp center cover at its mounting position and press downward to snap it onto place.
16. Replace the lift cove per Procedure 7.2.

Procedure 7.16 - Replacing a Handlebar

1. Remove the plastic cap from the inside lower end of the handlebar. Refer to Diagram 7.17. Remove the bolt that fastens the handlebar to the stairarm connector. There are two washers and a steel spacer in the stairarm connector.

Diagram 7.17 - Lower Handlebar Mounting

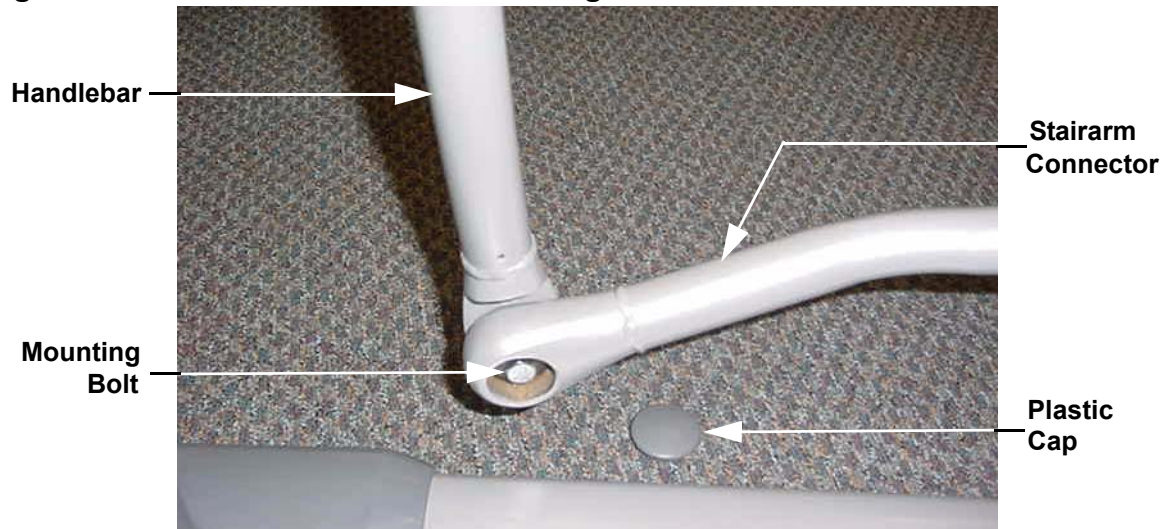

2. Remove the stairarm connector from the handlebar.
3. Remove the bolts that fasten the center of the handlebar to the handlebar pivot. Refer to Diagram 7.12.

Diagram 7.18 - Center Handlebar Mounting

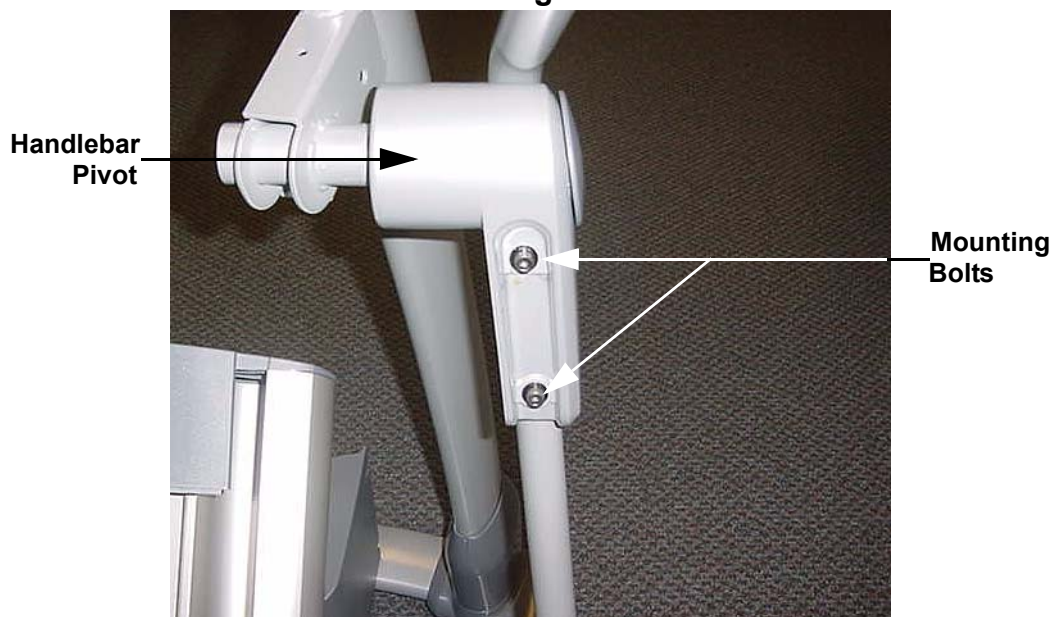

4. Set the handlebar at its mounting position and hand start the mounting bolts removed in step 3 that fasten the handlebar to the handlebar pivot. Do not tighten them at this time.
5. Slide the spacer into the stairarm connector and place a washer on each side of the spacer. Position the handlebar and the stairarm connector at their mounting positions and hand start the mounting bolt.
6. Securely tighten the handlebar to stairarm connector bolt. Replace the plastic cap on the stairarm connector.
7. Torque the handlebar to handlebar pivot bolts to 150 inch pounds.

Procedure 7.17 - Replacing a Stairarm Connector

WARNING

Before continuing with this procedure, review the Warning and Caution statements listed in Section One, Things You Should Know.

1. Remove the plastic cap from the stairarm end of the stairarm connector. Remove the bolt that fastens the stairarm connector to the stairarm. Refer to Diagram 7.14. There are two washers and a spacer in the stairarm connector.
2. Remove the plastic cap from the inside lower end of the handlebar. Refer to Diagram 7.17. Remove the bolt that fastens the handlebar to the stairarm connector. There are two washers and a spacer in the stairarm connector.
3. Remove the stairarm connector.
4. Slide the spacer into the bushing in the rear of the stairarm connector and place a washer on each side of the spacer. Set the stairarm connector at its mounting position and fasten it with the bolt removed in step 3. Securely tighten the stairarm connector bolt. Snap the plastic cap removed in step 3 into the stairarm connector.
5. Slide the spacer into the bushing in the front of the stairarm connector and place a washer on each side of the spacer. Position the handlebar and stairarm connector at their mounting positions and hand start the mounting bolt.
6. Securely tighten the handlebar to stairarm connector bolt. Replace the plastic cap on the stairarm connector.

Procedure 7.18 - Replacing a Generator

WARNING

When the unit is used, stairarms are in motion or the generator is rotated by any means, the generator will produce potentially hazardous voltages even when the battery is disconnected.

1. Remove the rear cover and disconnect the red battery lead from terminal M6 of the lower PCA.
2. Remove the three generator mounting screws shown in Diagram 7.19.
3. Remove the two bearing clamp screws shown in Diagram 7.20. Remove the bearing clamp.
4. Lift the generator and remove its drive belt.
5. Loosen all four generator mounting nuts. Loosen the locking nut on the generator's adjustment bolt and thread the adjustment bolt into tab to remove tension from the generator's drive belt. Remove the drive belt from the generator's pulley.
6. Remove the four generator mounting nuts. Disconnect the generator's cable connector from the intermediate cable and remove the generator from the EFX.
7. Remove the adjustment bolt and its locking nut from the generator's mounting base.
8. Thread the adjustment bolt and locking nut into the tab on the replacement generator.

Diagram 7.19 - Generator Mounting



9. Set the replacement generator at its mounting position. Remove the three generator mounting screws, the two bearing clamp screws and the bearing clamp. Lift the generator and place the drive belt around the generator's pulley.

Diagram 7.20 - Generator Bearing Clamp

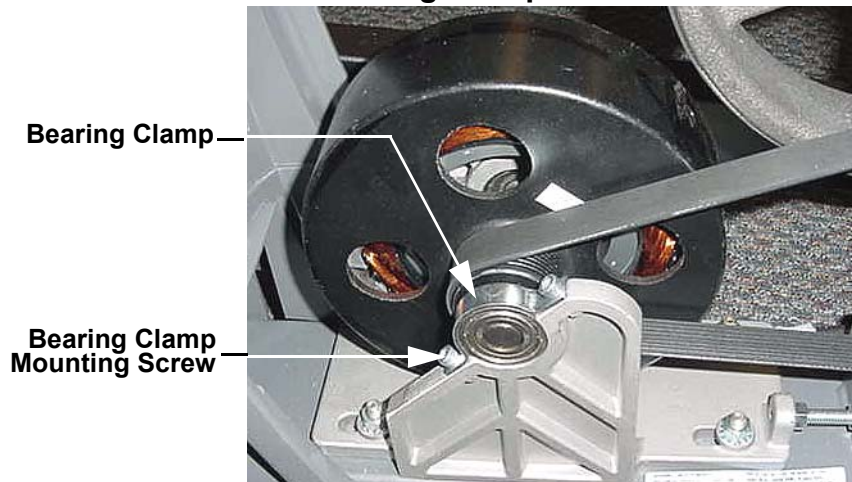

10. Replace and tighten the three generator mounting screws removed in step 9. Set the bearing clamp in its mounting position, replace and tighten the two bearing clamp mounting screws removed in step 9.
11. Hand start, but do not tighten the four mounting nuts removed in step 6. The generator must be able to move in order to adjust the belt tension.
12. Adjust the generator drive belt tension per Procedure 5.3.
13. Reconnect the red battery lead removed in step 1 and replace the rear cover.
14. Check the operation of the EFX as described in Section Four.

Procedure 7.19 - Replacing a Battery

1. Remove the lift cover per Procedure 7.2.
2. Remove the four screws that retain the lower front cover section, remove the lower front cover section and set it aside.
3. Remove the hitch pin from the clevis at the lower mount of the incline motor. Remove the clevis pin from the lower incline motor mount. Lift the incline motor out of its mounting position and set it on the floor in front of the EFX. Refer to Diagram 7.22.

Diagram 7.22 - Replacing a Battery

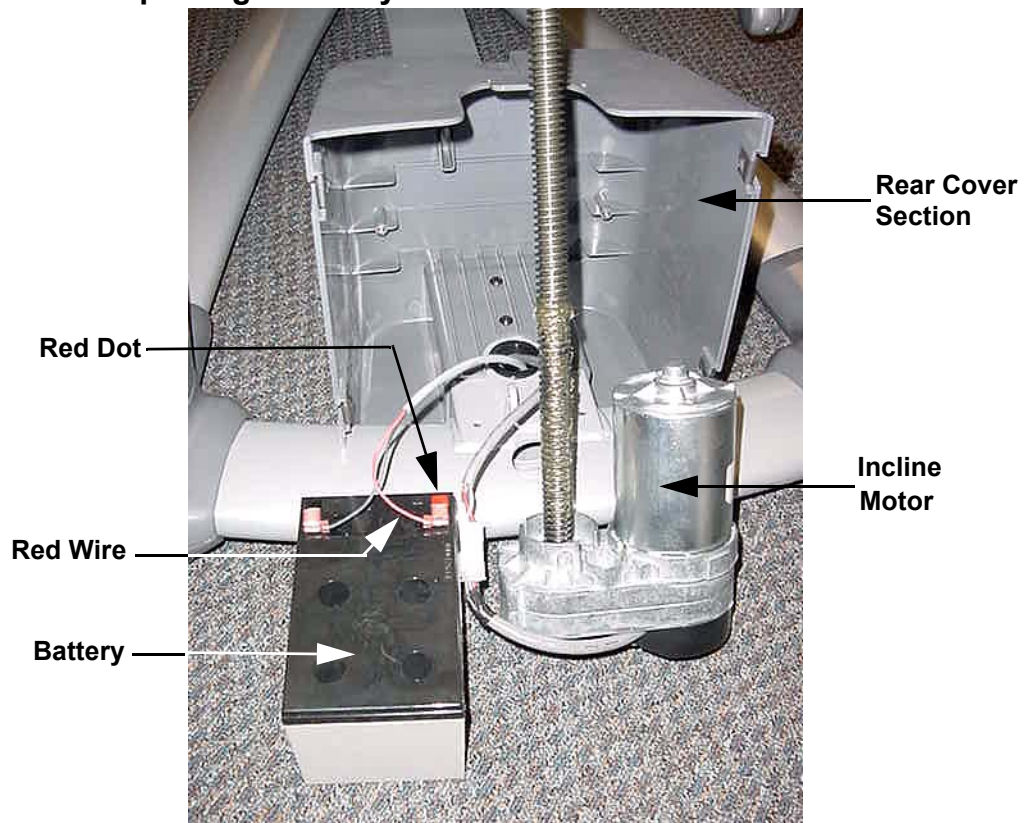

4. Remove the two screws that fasten the battery bracket to the rear cover section and remove the battery bracket.
5. Slide the battery out of the rear cover section and set it on the floor beside the incline motor.
6. Disconnect the red and black wires from the battery.
7. Connect the red and black wires disconnected in step 6 to the replacement battery. The red wire must be connected to the terminal marked with the red dot.

8. Set the battery in its mounting position. Set the battery bracket in its mounting position and fasten it with the screws removed in step 8.
9. Set the incline motor in its mounting position and slide the clevis pin into the incline motor's lower mount. Fasten the clevis pin with the hitch pin.
10. set the lower front cover section in its mounting position and fasten it with the four screws removed in step 2.
11. Replace the lift cover per Procedure 7.2.

Procedure 7.20 - Replacing an External Power Input Jack

1. Remove the left and right side rear covers sections per Procedure 7.1.
2. Disconnect the J4 connector from the lower PCA.

Diagram 7.23 - Power Input Jack Mounting

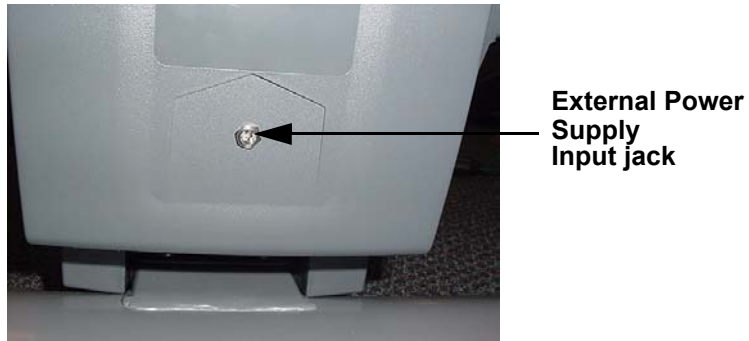

3. Remove the nut that fastens the external power input jack to the rear cover support. Refer to Diagram 7.23.
4. Remove the power jack's wiring from the wire clips and discard the power jack and wiring.
5. Fasten the replacement external power input jack into the cover with the mounting nut provided with the power input jack.
6. Route the power input jack wiring through the wire clips to the lower PCA. Connect the plug on the power input jack wiring to the J4 connector on the lower PCA.
7. Replace the left and right side rear covers.
8. Check the operation of the EFX as described in Section Four.

Procedure 7.21 - Replacing the PROM

Anti-static kits (part number 20024-101) can be ordered from Precor.

1. The PROM and the associated printed circuit assembly (PCA) are static sensitive. Anti-static devices must be used and all anti-static precautions must be followed during this procedure.
2. Remove the printed circuit assembly per its associated procedure.
3. Currently we are using two styles of IC software packages. they are a 28 pin dual in line package (DIP28) and a forty-four pin square package (PLCC44). Each of these packages should be removed with a proper IC removal tool (Refer to the illustrations below)



4. The IC's may inserted into their socket by hand by carefully aligning the notch on the IC with the notch on the IC socket and carefully pressing the IC into its socket. Refer to the illustrations below for the alignment notches. Care must be taken that the IC legs on a DIP28 are all aligned in the socket to prevent the legs from bending when inserted. The PLCC44 IC must be carefully aligned squarely in its socket or it will not insert. Do not force the IC into its, socket. If it does not insert easily, remove the it and re-align it in its socket.

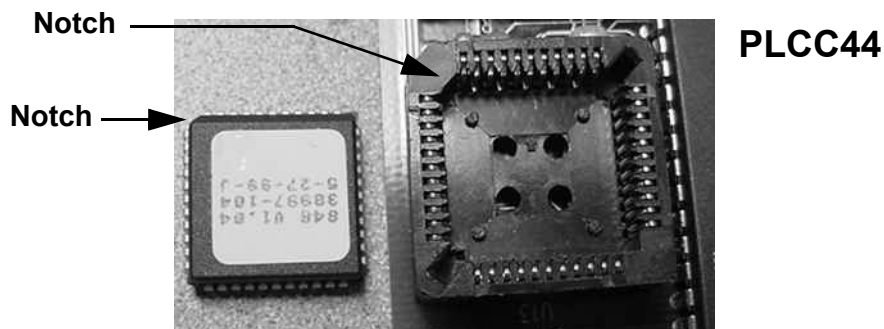
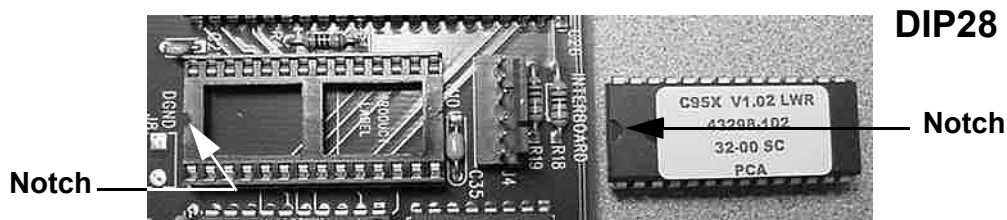

Wiring Diagram 8.1 - C576i Self Powered

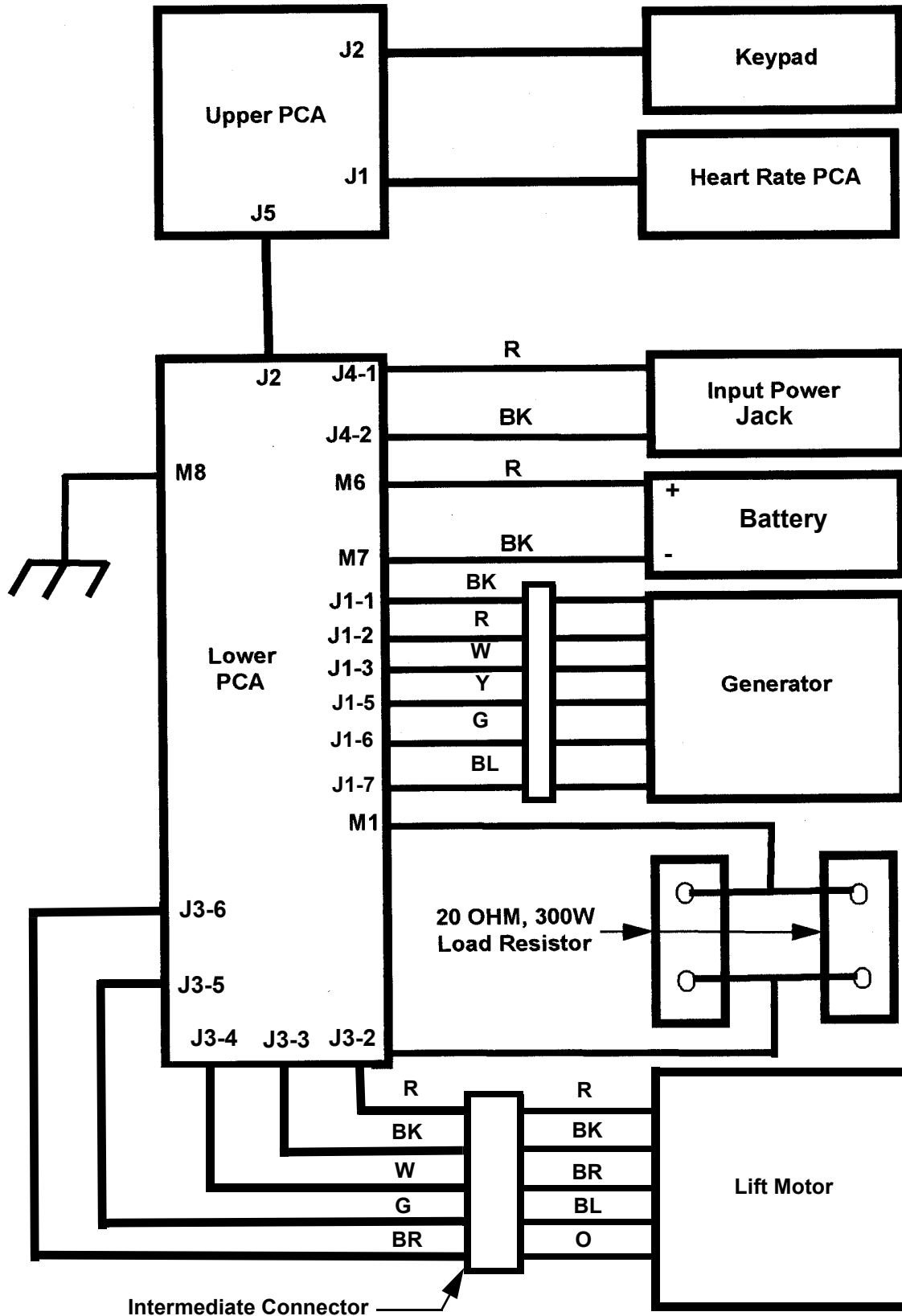

Block Diagram 8.2 - C576i Self Powered

PRECOR
USA

C576i Self Powered EFX

